

GB

*Dear Client,
We would like to congratulate as well as thank you
for the trust your purchase has bestowed on us.*

*Our products are the result of meticulous technical
testing, together with our extensive experience in
designing and manufacturing household cleaning
appliances.*

*We have prepared this handbook, so that you will
be able to use this appliance in the best possible
manner and fully appreciate its superior quality.
We are certain that, by carefully following the
enclosed suggestions, you will benefit from the
use of this appliance for a long time and will
obtain the best possible results from it.*

*With this appliance, daily household cleaning will
be much easier.*

DESCRIPTION

- | | | | |
|----------|--|----------|---|
| A | Two (2) extension tubes or one (1) telescopic tube | I | Cable wind and (certain models only) ON/OFF pedal |
| B | Flexible tube / handle | L | Power regulator (certain models only) |
| C | Power regulator (certain models only) | M | Rear filter |
| D | Multi-purpose nozzle for upholstery | N | Air outlet grid |
| E | Brush nozzle | O | Button to open the dust-collecting compartment |
| F | Crevice nozzle | P | Carpet and floor brush |
| G | Full bag indicator | Q | Strap |
| H | Handle | | |

IMPORTANT

- Read this instruction booklet care fully and keep it in a safe place for future consultation.
- Before using the appliance for the first time, check that the voltage of your power supply is the same as that indicated on the appliance data plate.
- Only plug the appliance into sockets with a minimum 10A current capacity.
- Always unplug the appliance from the socket when it is not in use, or before beginning any maintenance or cleaning operations on the appliance itself.
- Never wash the appliance with trichloroethylene or other solvents.
- Do not vacuum liquids.
- Never leave the appliance unattended if it is turned on; keep it out of the reach of children or incapable persons.
- It should only be used for domestic cleaning as given in the instruction hand book.
- If the appliance seems faulty in any way, do not turn it on.
- For repairs or the purchase of spare parts contact your retailer or go directly to an Authorised Service Centre.
- The manufacturer accepts no responsibility for any damage caused by improper or incorrect use of the appliance.

The manufacturer reserves the right to make changes to the appliance and accessories without any prior notice.

Never pull on this equipment's feed cable in order to disconnect its plug from the socket.

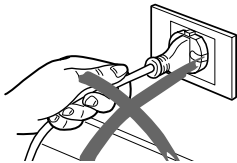

Avoid the supply lead getting caught around the wheels of the appliance.

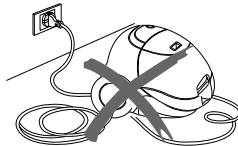

Do not vacuum matches, ashes or cigarettes butts that have not been completely extinguished.



Do not use this equipment on wet surfaces.

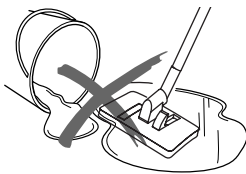

Do not block the vacuuming nozzle or the air outlet.



Do not vacuum needles, tacks or pieces of twine.

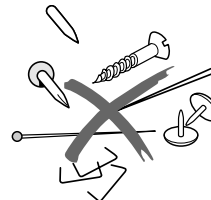

ASSEMBLY INSTRUCTIONS

Always disconnect the plug from the socket, before beginning assembly or dismantling the accessories.

Fitting the accessories

Fit the tube into the housing on the appliance and push it well in until it clicks in place (Fig. 1/A). To remove the tube, press the side-blocking lever and then pull the tube (Fig. 1/B).

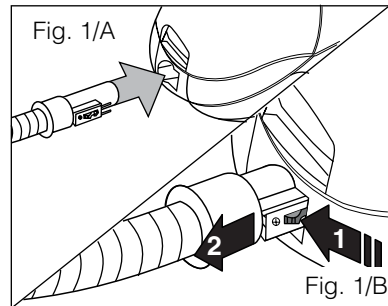

Suction tube:

Join the telescopic tube to the end of the grip on the flexible suction tube. Once the telescopic tube is fixed on the grip, turn the black plastic cylinder on the telescopic tube to the left, to pull out the bottom inside part of the telescopic tube (Fig. 2). Adjust the telescopic tube to the required length and block it by turning the black plastic cylinder to the right. Then fit the required nozzle to the other end.

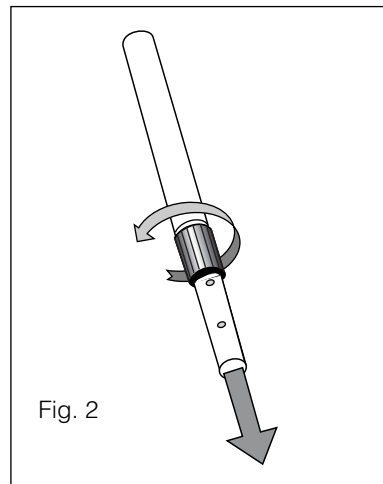

If your vacuum cleaner does not come with a telescopic tube ensemble, connect the two tubes (fig. 2a), hook them up to the handle of the flexible tube, and attach the nozzle you want to use to the other end.

N.B: All the suction-type accessories can be connected either directly to the handle of the flexible tube or to the stiff tube. The flexible tube and the stiff tubes may also be used without the suction-type accessories.

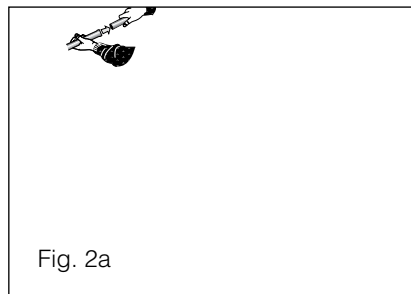

USING THE CLEANING ACCESSORIES

- **Carpet and floor brush** with two settings

Setting 1: to clean hard floors, with the bristles out ().

Setting 2: to clean rugs and carpets, with the bristles in ().

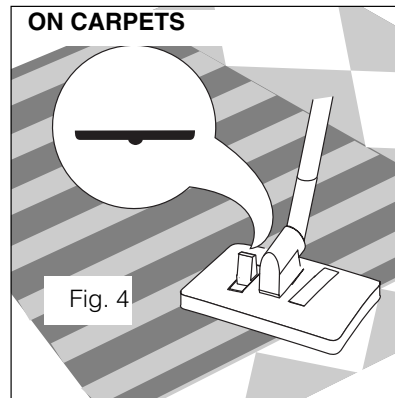
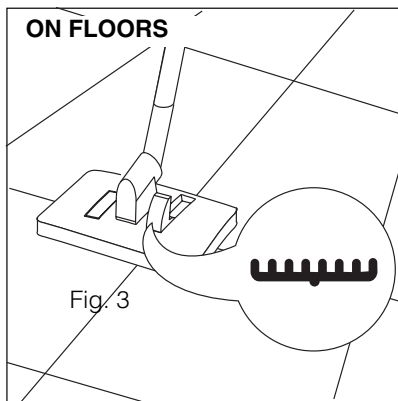

Fix the position of the bristles by adjusting the lever on the suction nozzle.

- **Crevice nozzle**
for cleaning radiators, corners, edgings, drawers, etc

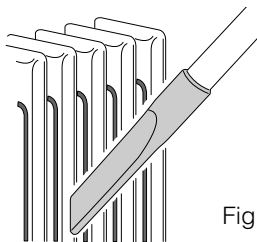

- **Multi-purpose nozzle for upholstery**
for cleaning upholstered furniture, mattresses, quilted clothing, automobile seats, etc

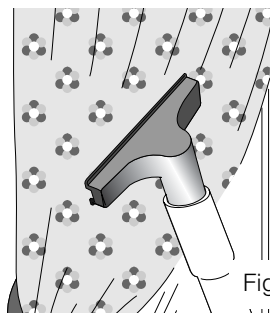

- **Brush nozzle**

This has a ball joint to make cleaning easier and is ideal for cleaning fabrics, furniture, books, curtains, frames and clothes.

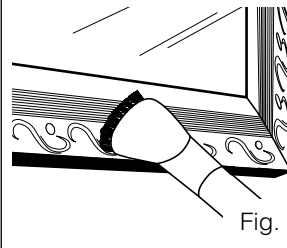

INSTRUCTIONS FOR USE

Before using the appliance, pull the supply lead all the way out and then plug it into the socket. To rewind the lead, remove the plug and press the rewind pedal **(I)**.

Turning on

Models with power regulator on handgrip **(C)** (fig. 8)

To turn the appliance on and off, use the slide on the hose handgrip. The slide **(C)** also regulates suction power.

Models with ON/OFF switch **(I)** and power regulator **(L)** (fig. 9).

To turn the appliance on and off, press the ON/OFF **(I)** pedal **(I)**. The slide **(L)** regulates suction power.

In these vacuum cleaner models, the handle of the flexible tube has a built-in mechanical device to control the suction. By simply moving the cursor, you can quickly and easily change the vacuuming power.

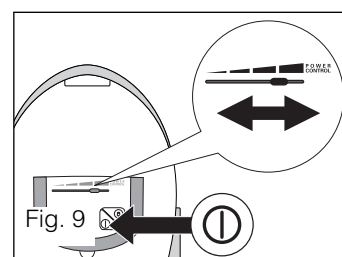
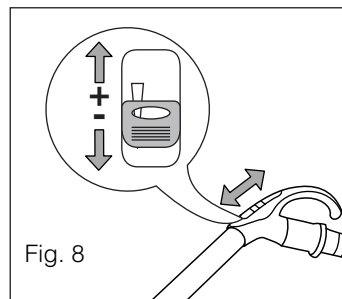

CLEANING FULL BAG INDICATOR

When the indicator changes colour **(G)**, it means the bag needs changing or that something is blocking suction.

Replacing the bag

To remove the bag, press the switch to open the dust-collection compartment **(O)** and lift the lid (Fig. 10). Carefully remove the bag by pressing on the blocking lever, slightly pushing the bag backwards. This makes it easy to remove the bag (Fig. 11).

Throw the old bag in the rubbish bin.

Fit the rigid part of the bag in the slot in the dust-collection compartment (Fig. 12).

Check that the suction tube is perfectly fitted into the bag opening and then fit the new bag in place using the blocking lever.

To correctly position the new bag, remember that the two side folds must be in a vertical and not horizontal position.

We advise changing the bag frequently, when very fine dust is vacuumed like flour, talc or other similar substances.

The lid will not close if there is no bag fitted.

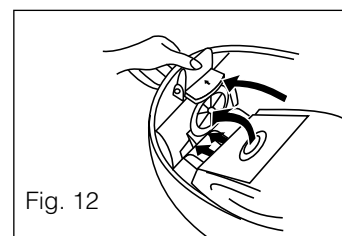
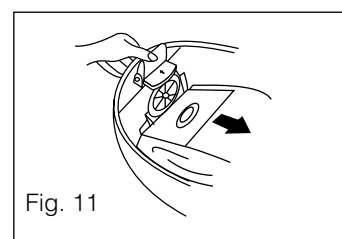
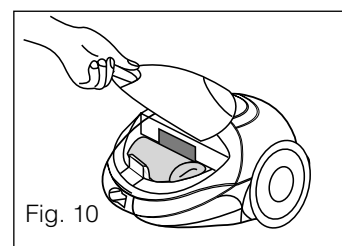

Motor protection filter

To guarantee long life to the appliance and protect the motor, the motor protection filter must be kept clean.

To reach the filter, open the dust-collection compartment, remove the bag and the filter (Fig. 13). If it is not very dirty, just remove the dirt. If it is very dirty, it must be washed and dried.

Make sure the filter is completely dry before replacing it in the cleaner.

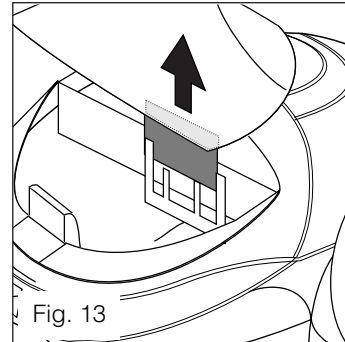

Rear filter

Remove the rear grid (M), remove the filter and wash it in water. Once it is completely dry, replace it in its housing.

After replacing the filter, replace the grid in the correct position (Fig. 14).

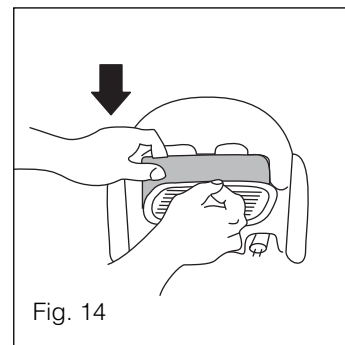

Warning:

Never use the cleaner without the filter.

Never wash the filter in the washing machine, or use a hair dryer to dry it.

Shoulder strap:

For the more difficult situations, a shoulder strap is supplied (Q) which is easily fitted to the cleaner (Fig. 15).

