

DeLonghi

DEHUMIDIFIER



**USER'S
MANUAL**







CF05M、CF08M

Contents

Structure and principle	Features	1
	Specifications	2
	How dehumidifying works	2
	Description	3
Operation	Control panel	4
	Operation	5
	Draining the water	6
	Moving the dehumidifier	7
Maintenance	Caring for the dehumidifier	8
	Storing the dehumidifier	9
	Important Safeguards	9
	Troubleshooting	10

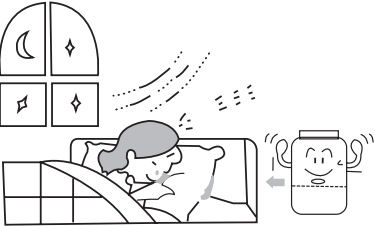
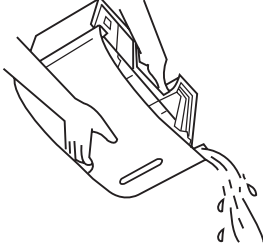
- Before using your dehumidifier, please read this user's manual carefully, in order to ensure correct and safe use. After reading the manual, make sure it is stored in a safe place for future reference if necessary.

● **Features**

<p>Powerful dehumidifying capability</p>	<p>Excellent drying laundry function</p>
<p>The dehumidifier powerfully removes excess moisture from the air creating a drier, healthier home environment.</p> 	<p>The dehumidifier dries laundry quickly. This can prevent laundry and furniture from becoming damp and musty in a rainy season.</p> 
<p>Quiet operation</p>	<p>Drainage tank with a large capacity</p>
<p>For overnight operation, the QUIET mode may be selected.</p> 	<p>Large 6 litre capacity water tank means the dehumidifier requires emptying less often.</p> 
<p>Using refrigerant for protecting environment</p>	<p>Modern Design</p>
<p>The dehumidifier uses no CFC refrigerant therefore protecting the environment.</p> 	<p>The dehumidifier is compact with a streamlined appearance and modern design. The castors at the bottom allow easy mobility.</p> 
<p>Saving energy</p>	
<p>The power consumption is low.</p> 	

Specifications

Model	CF08M	CF05M
Power Supply	220 ~240V ~ 50Hz	
Dehumidifying Capacity	0.8L/h	0.5L/h
Power Consumption	360W	200W
Drainage Tank Capacity	6.0L	
Weight	14kg	12.5kg
Dimension(height × width × depth)	380mm × 545mm × 261.5mm	

- The dehumidification capacity is the value obtained after the dehumidifier was continuously run in the room temperature of 30°C with the relative humidity 80%.
- The amount of dehumidification is the amount per day(24 hours).
- The manufacturer reserves the right to change specifications without prior notification.
- The work temperature is in the range 2°C to 38°C. If the room temperature is beyond the range, the unit can not operate normally.

● How dehumidifying works

If you pour cold water into a cup, the air around the cup is cooled, and drops of water form on the surface of the cup. The dehumidifier takes advantage of this phenomenon to remove moisture.

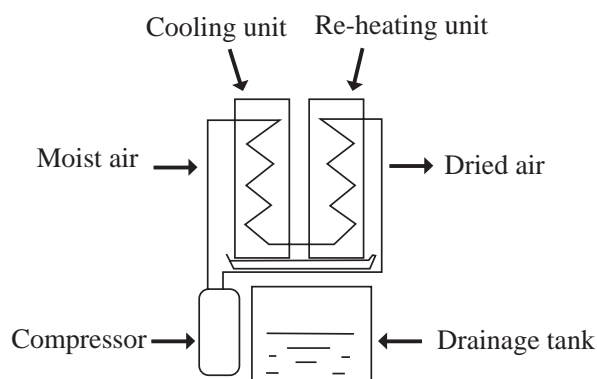

- ① It draws in room air, cools it with a cooling unit, and changes the humidity to drops of water.
 - ② The drops of water fall into a drainage tank.
 - ③ The dehumidified air is re-heated by a heating unit and discharged.
- Steps ①, ②, and ③ are repeated to remove humidity from the room.

- After the air passes through the re-heating unit, its temperature will rise a little, so that the temperature of the room will rise by 2 to 4°C. This is normal operation.

● Description

Front panel

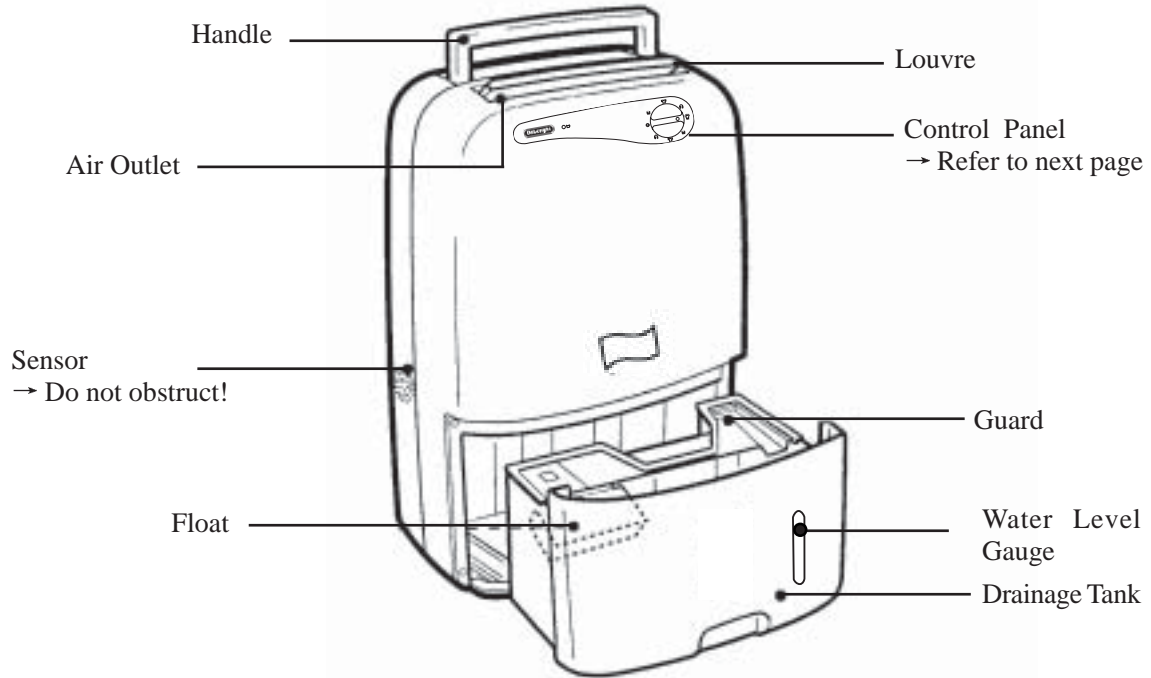

When the unit is purchased, there may be some water left in the drainage tank. This is from the dehumidifying test conducted at the factory, and does not indicate a problem.

Back panel

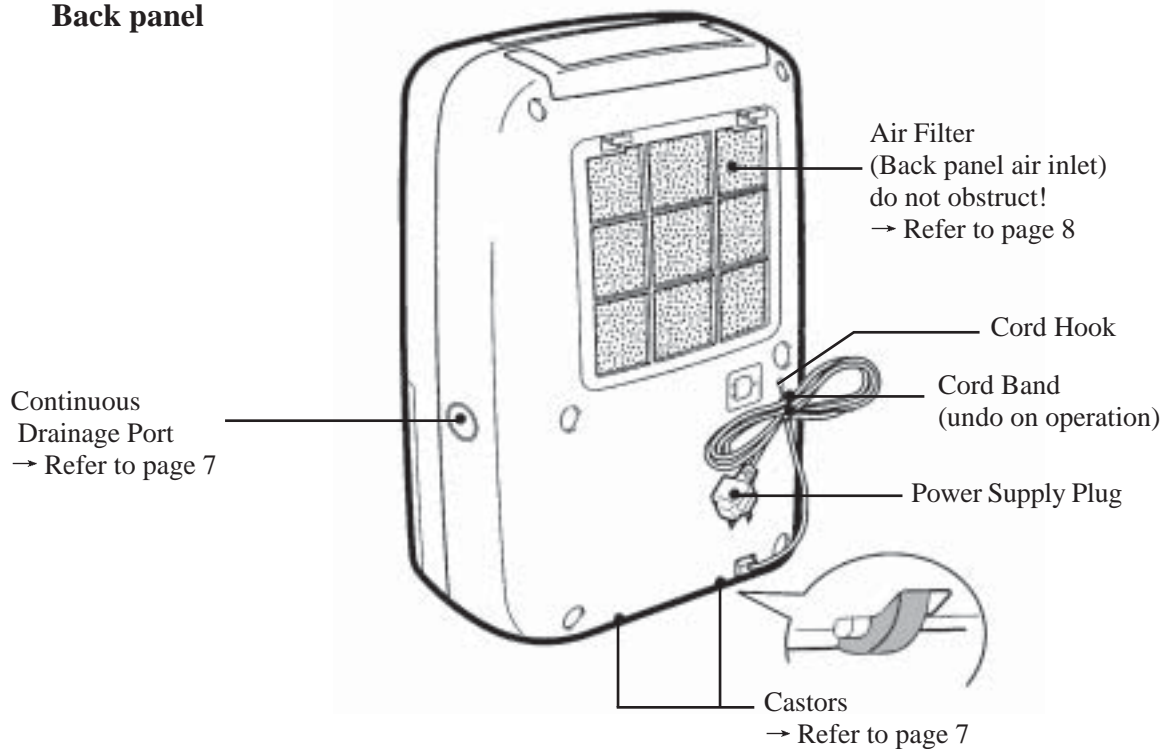

Operation

● Operation panel

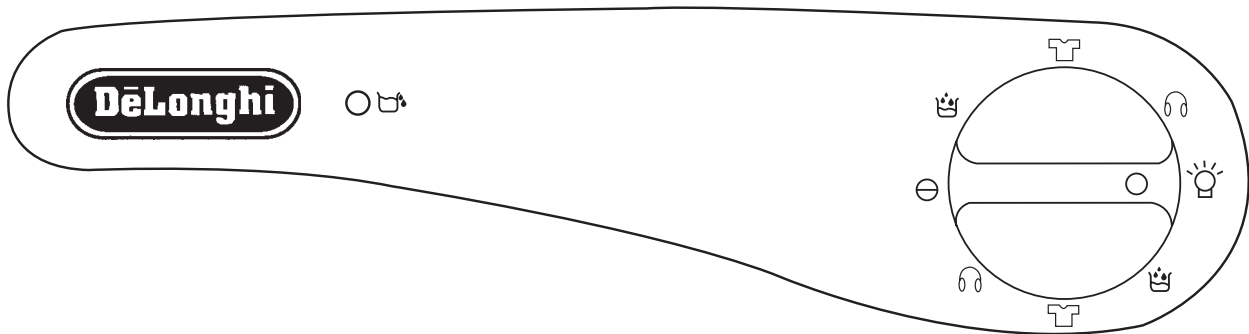

Indicator lamp

1. “” (Tank full indicator lamp):

It will light when the drainage tank is full or positioned incorrectly. Empty the water out of the drainage tank, and make sure the tank is positioned properly.

2. “” (Power indicator lamp):

It will light when the unit is plugged in.

3. DEHUMIDIFY mode: Turn the control switch to “”. Operation is continuous, with the amount of discharged air at the middle level.

4. LAUNDRY mode: Turn the control switch to “”. Operation is continuous, with the amount of discharged air at the high level. This is appropriate for enhanced dehumidifying, drying clothes or other items.

5. QUIET mode: Turn the control switch to “”. Operation is continuous, with the amount of discharged air at the low level. This suppresses operation noise when dehumidifying (Under the condition of high temperature and high humidity, please avoid operating the unit in QUIET mode, as this can decrease the life of the unit.)

Operation

1.Plug the power supply plug into the outlet

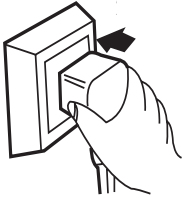

- Use single phase 220V ~ 240V AC power supply.
- Wipe dust off of the power supply plug and insert the plug firmly, all the way to the rubber section, if there is a dust on the plug, or the plug is not fully inserted in the outlet, electrical shock and/or fire may result.
- Never scratch, cut, or damage the power supply cord.
- Power indicator lamp lights to indicate that power is on.

2.Open the louver by hand

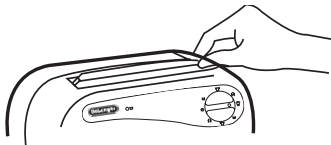

- Before operation please check and make sure the louver has been opened to ensure adequate air flow.
- Set louvre to desired angle (when room temperature is above 32 °C set louvre to vertical position to allow maximum air flow.)

3.Switch the operation mode

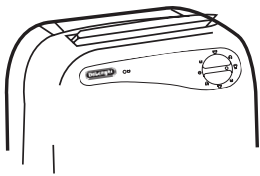

- DEHUMIDIFY mode: Turn the control switch to “☼” . Operation is continuous ,with the amount of discharged air at the middle level.
- LAUNDRY mode: Turn the control switch to “☀” . Operation is continuous,with the amount of discharged air at the high level.This is appropriate for enhanced dehumidifying,drying clothes or other items.
- QUIET mode: Turn the control switch to “🔇” . Operation is continuous,with the amount of discharged air at the low level.This suppresses operation noise when dehumidifying (Under the condition of high temperature and high humidity,please avoid operating the unit in QUIET mode,as this can decrease the life of the unit.)

4.Stop operation

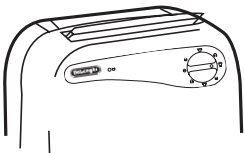

Turn the control switch to “☹”





- Dehumidifying stops.
- Never stop the unit by unplugging the power supply cord.
- Be sure after 3~ 5 minutes to restart the unit again when the unit is stopped or power supply is cut.

Operation

● Draining the water

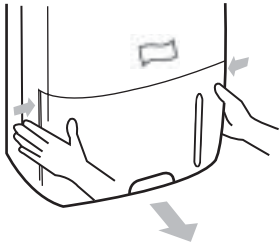
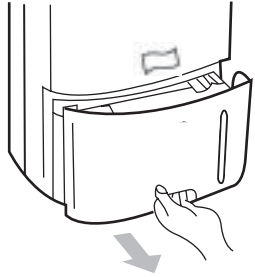
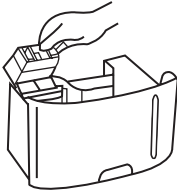
The drainage tank is full

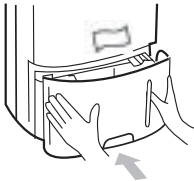
When the drainage tank becomes full (approx, 6 Litres), the full indicator lights to alert the user, and the unit turns off automatically. Empty the water from the tank and discard it.

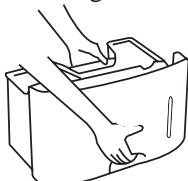
Drainage steps	Notation for drainage
<p>1. Remove the drainage tank Lightly pressing on the sides of the tank with both hands, pull it gently out.</p>  <p>Take hold of the handle, and then remove the tank.</p> 	<ul style="list-style-type: none"> Do not remove the bubble packing from the float on the unit. The float on the unit will no longer be able to detect without the bubble packing when the water level is full, and water may leak from the tank.  <ul style="list-style-type: none"> If the drainage tank is dirty, wash it with cold or lukewarm water. Do not use detergent, scouring pads, chemically treated cloths, or other cleaning solutions as it may damage the drainage tank. 
<p>2. Discard the water</p> <p>Guard</p>  <p>Drain water from this point</p>	<ul style="list-style-type: none"> When replacing the drainage tank, press the tank firmly into place with both hands. If the tank is not positioned properly, the “ Tank Full” sensor will activate, and the dehumidifier will not operate. Check to make sure the guards are firmly attached to the tank. If they are not, the drainage tank will be harder to remove. 
<p>3. Place the drainage tank back in it's compartment.</p> 	<ul style="list-style-type: none"> If the drainage tank is removed while the unit is in operation, or immediately after operation has stopped, water which is still in the cooling unit may drip out on the base plate. Wait at least 30 minutes before removing the drainage tank.(If water has dripped, wipe it up.) 

Operation

● Draining the water

Continuous drainage of water

The unit has an optional continuous drainage port. Water can be continually drained by connecting a rubber hose (15mm I.D), to this drainage port. When setting up the dehumidifier for continuous drainage, always turn the unit off and unplug the supply plug.

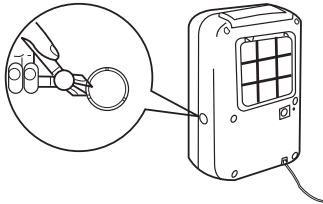

1. Disconnect the drainage tank and open the continuous drainage port.

Use sidecutters or similar tool to cut away the continuous drainage port in the side of the main unit.

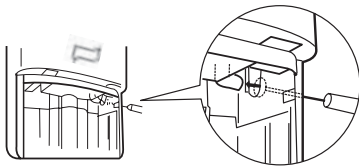

2. Push the hose into the continuous drainage port

Pass a rubber hose (15mm I.D) through the continuous drainage port, and press it firmly into the drainage port in the main unit, making sure water does not leak.

The height of drain piping should always be lower than the height of the drainage port.

Make sure there are no kinks or obstructions in the rubber hose which may prevent the water draining out.

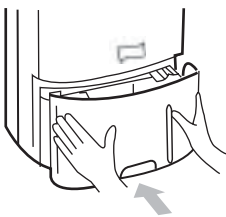

3. Return the drainage tank to its original position

Check the hose periodically to make sure it is still connected and has not been obstructed.

● Moving the dehumidifier (using castors)

1. Drain the water.
2. Lift up the handle.
3. Move the unit.

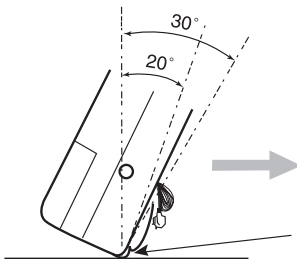

Ensure the dehumidifier has adequate clearance between the unit and nearby walls as shown below.

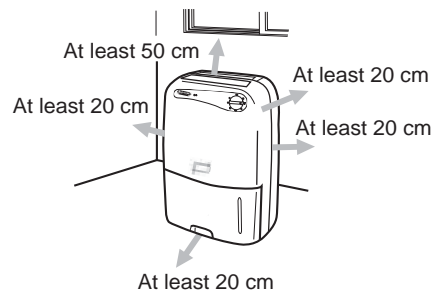

Note:

1. If the floor is made of a material that scratches easily, or if the floor is uneven, lift up the unit and move it. Also avoid rolling the unit on castors if the floor has shagpile carpet.
2. Tilt it within range of 20 to 30 degrees, as a rule (if you tip it too far, you may scratch the floor or water may leak.)
3. Be careful that the power supply cord doesn't get pinched under the unit.

Maintenance

● Caring for the dehumidifier

Cleaning the Unit



Wipe it with a soft cloth

Use a soft, clean cloth to wipe the surface.
(Do not use volatile chemicals, detergents, chemically treated cloths or other cleaning solutions. These could possibly damage the unit.)

Cleaning the air filter

The air filter should be cleaned approximately once every two weeks.

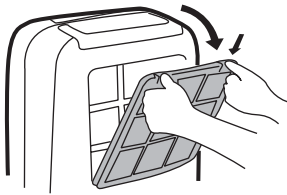

1. Remove the air filter

Press downward on the tabs on the air filter to remove it.

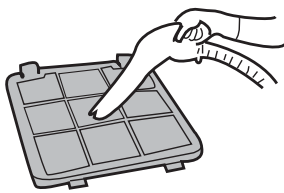

2. Clean the air filter

Run a vacuum cleaner lightly over the surface of the air filter to remove dirt. If the air filter is very dirty, wash it with warm water and a neutral cleaning solvent and dry it thoroughly.

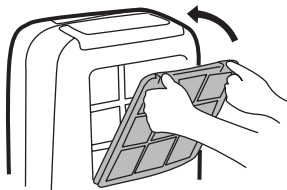

3. Attach the air filter

Insert the lower tabs of the air filter into the main unit and press the air filter until you hear the tabs click into place.

Maintenance

● Storing the dehumidifier

When the unit is not to be used for a long period of time

1. Fold up the power supply cord.
2. Discard any water left in the drainage tank and wipe away any remaining drops with a cloth.
3. Clean the air filter.
4. Store the unit
Package the unit to keep it free of dust, and keep it upright and store in a cool, dry place.

● Important Safeguards

Please note the following safety precautions when using the unit:

1. When the dehumidifier is used in the laundry, ensure there is adequate clearance between the clothes and the unit as described on page 7, and prevent water dripping on the unit.
2. Before cleaning the unit or when it is not in use for a long period of time, unplug the power supply cord.
3. Do not use the dehumidifier in the immediate surroundings of a bath, shower, or swimming pool.
4. Do not place the unit close to a heater, or any appliance which will have a high temperature.
5. Do not place any objects into the Air Inlet or Outlet.
6. Do not sit or stand on the unit.
7. Discard water that has collected in the tank regularly.
8. Do not place the dehumidifier in an enclosed area i.e. closets, which will prevent air circulation.
9. Do not use the dehumidifier for any purpose other than for which it was originally intended.
10. Install the external drain piping on a downhill gradient to ensure that condensed water can be drained continuously.
11. If the supply cord is damaged, it must be replaced by the manufacturer or its service agent or a similarly qualified person in order to avoid a hazard.
12. The appliance is not intended for use by young children and the infirm without supervision.
13. Young children should be supervised to ensure they do not play with the appliance.

Maintenance

● Troubleshooting

If a condition listed below occurs, please check the following items before seeking advice.

Condition	Cause	What to do
The unit does not operate.	Has the power supply cord been disconnected?	Plug the power supply cord into the outlet. → Refer to page 5
	Is the “Full” light blinking?(The tank is full or incorrectly positioned.)	Discard the water in the drainage tank, and then reposition the tank. → Refer to page 6.
	Is the temperature of the room above 38°C or below 2°C.	The protection device has activated. Please wait for the room temperature to be within these limits.
The dehumidifying function does not work	Is the air filter clogged?	Clean the air filter as instructed under “Caring for the dehumidifier”. → Refer to page 8.
	Is the air inlet or outlet obstructed?	Remove what ever is obstructing the air inlet or outlet.
No air is discharged	Is the air filter clogged?	Clean the air filter as instructed under “Caring for the dehumidifier”. → Refer to page 8.
	Is the louver open?	Check to see if opened
Operation is noisy.	Is the unit sitting on an angle or unsteady?	Move the unit to a more stable location.
	Is the air filter clogged?	Clean the air filter as instructed under “Caring for the dehumidifier”. → Refer to page 8.

- After following the steps above, and the fault persists, please contact De’Longhi Ltd for service:
Australia: 1800 126 659
New Zealand: 0508 200 300

Maintenance

● Troubleshooting

The following symptoms do not indicate a breakdown

Symptom	Reason
Noise level increases during use.	The sound level increases when the compressor turns on.
The humidity does not drop.	Is the room too big for the unit? Are windows or doors opened and closed frequently? Is there any item in the room which produces steam?
Very little dehumidifying takes place, or none at all.	This happens if the temperature and/or humidity of the room is low.
When the unit is first used, the discharged air smells musty.	Because the temperature of the heat exchanger rises abruptly, an unusual or musty odor may be produced for a moment.
The unit echoes.	If the unit is used in a room with wood flooring or in a small room, it may echo.
When the unit is turned on, or a different mode is selected a strange noise is heard from the main unit.	The refrigerant may make some noise until circulation stabilizes.
Fluid or a white film is left in the drainage tank.	This is water or steam residue left from dehumidification testing at the factory. This does not indicate a problem.
The unit will only run in "Hi" mode, regardless of any other mode being selected.	When the temperature of the room is above 35°C the protection device is activated, which will only allow the unit to run in "Hi" mode. When the room temperature is below 15°C, the compressor operates at intervals of 40 minutes on and 10 minutes off, or the automatic defrost function had been initiated and the compressor will turn off temporarily.
The fan is running and the compressor does not work.	If the unit is started with in 3 minutes of the unit turning off, the protection device is activated, which will initiate a 3 minutes delay on the compressor turning on, or the automatic defrost function has activated turning the compressor off temporarily.