



## **AUTOMATIC ICE CREAM MAKER**

Instructions for use

**ICK5000**

Proudly distributed by

**De'Longhi Australia Pty Limited**

P.O. BOX 4540

CASULA MALL NSW 2170

Customer Service Ph: 1800 126 659

Fax: 1800 706932

[www.delonghi.com.au](http://www.delonghi.com.au)

e-mail: [delonghi@delonghi.com.au](mailto:delonghi@delonghi.com.au)

**De'Longhi New Zealand Limited**

99 Khyber Pass Road

Grafton 1023

Auckland, New Zealand

P.O. Box 58-056 Botany

MANUKAU 2163

Customer Service Ph: 0508 200 300

Fax: 0508 200 301

[www.delonghi.co.nz](http://www.delonghi.co.nz)

e-mail: [delonghi@delonghi.co.nz](mailto:delonghi@delonghi.co.nz)

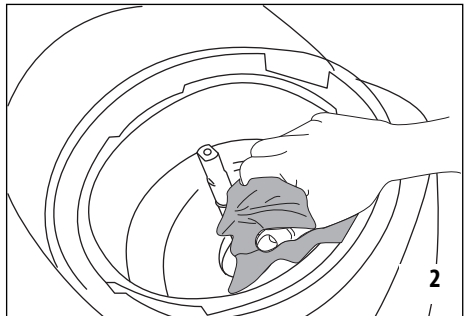
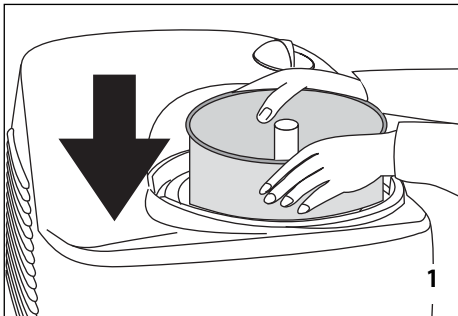
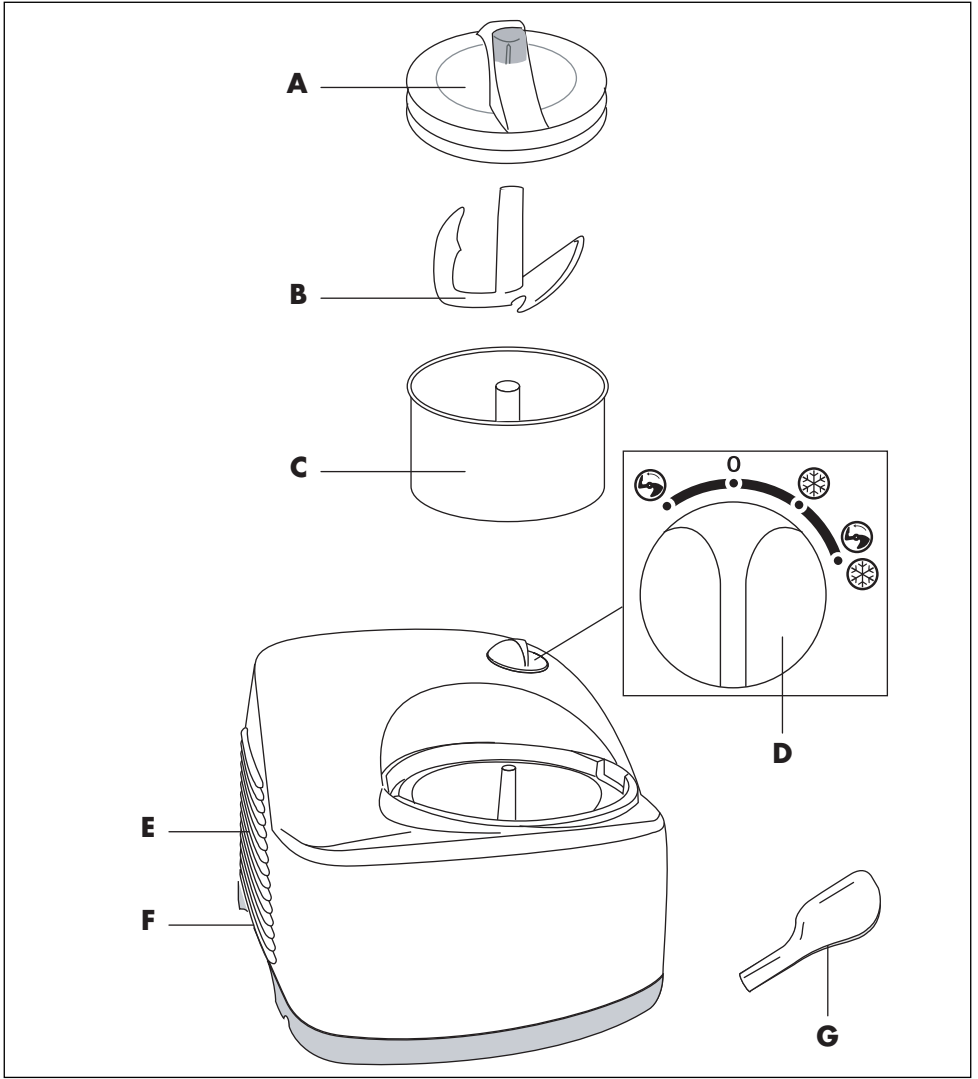

## IMPORTANT SAFEGUARDS

### Read all this manual thoroughly before using the appliance.

This is the only way to ensure the best results and maximum safety for the user. Save these instructions for future reference.

- The appliance must not be modified in any way, as any modifications may be extremely dangerous.
- The appliance must be installed in conformity with national legislation regulating electrical equipment.
- Before using the appliance, check that the mains supply voltage corresponds to the voltage indicated on the rating plate.

Connect the appliance to an efficiently earthed power supply and sockets with a minimum current rating of 10A only.

- If the socket and the plug of the appliance are incompatible, the socket should be changed by a qualified professional only.
- The manufacturer cannot be considered responsible for damage caused by the absence of an earth connection on the power supply line.

If in doubt, consult a qualified professional.

- If the supply cord is damaged, it must be replaced by the manufacturer or its service agent or similarly qualified person in order to avoid a hazard.
- This appliance must be used exclusively by adults.
- This appliance is not intended for use by persons (included children) with reduced physical, sensory or mental capabilities or lack of experience and knowledge, unless they have been given supervision or instruction concerning use of the appliance by a person responsible for their safety.

Children should be supervised to ensure that they do not play with the appliance.

- After removing the packing, make sure the appliance is not damaged. If in doubt, do not use the appliance and contact a qualified professional.
- Do not leave packaging (plastic bags, polystyrene foam, etc) within reach of children as it could be dangerous.
- The materials used for packaging can be recycled. You are therefore recommended to dispose of them in special differentiated waste collection containers. Do not use an extension cable.

- Do not install the appliance in rooms containing gas, oil or sulphur. Do not install near sources of heat.
- Do not store explosive substances such as aerosol cans with a flammable propellant in this appliance.
- Keep the appliance at least 50 cm away from flammable substances (alcohol etc) or pressurised containers (e.g. aerosol cans).
- Do not rest heavy or hot objects on top of the appliance.

- This appliance is intended for household use only. It must be used only indoors. Any other use is considered improper and thus dangerous.
- The manufacturer is not liable for damage caused by inappropriate, incorrect or irresponsible use or for damage resulting from repairs carried out by unqualified personnel.

#### Important:

- **The appliance must not be laid on its side or turned upside down.**
- **Wait at least 1 hour after transporting the appliance before starting it.**
- **Do not leave the selector in the  position for more than 1 minute.**
- **After the compressor goes off, always wait at least 5 minutes before starting it again.**
- **Use the appliance away from heat sources. Leave at least 20 cm between the appliance and walls or objects which could obstruct free air circulation.**
- **Do not remove the lid while the dasher is moving.**

The use of all electrical appliances implies the observance of some fundamental rules. In particular:

- Never touch the appliance with wet or damp hands or feet. Never immerse the appliance in water.
- Never use the appliance in bathrooms.
- Do not pull the power cable.
- Before cleaning or servicing, disconnect the appliance by unplugging from the mains.
- In the event of malfunction or faulty operation, switch off and do not attempt to repair.

For all repairs contact the manufacturer's authorised Customer Services only and ask for original spare parts. Failure to respect the above could reduce the safety of the appliance.

- When the appliance is to be discarded, after unplugging from the mains, the cable should be cut to make the appliance unusable.
- Unplug the appliance when not in use. Do not leave plugged in unnecessarily.
- At the end of its working life, take the appliance to a specialist waste collection centre.

Materials and accessories coming into contact with food conform to EEC directive 1935/2004.

This appliance also complies with the relevant EC directives, including on radio interference suppression.

## ENVIRONMENTAL INFORMATION:

This unit contains fluorinated greenhouse gases covered by the Kyoto Protocol.





Maintenance and disposal must be carried out by qualified personnel only. (R134a - GWP=1300)

**Transport, filling, cleaning, recovery and disposal of refrigerant should be performed by the manufacturer's authorised Customer Services only. The appliance should be disposed of by a specialist centre authorised by the manufacturer only.**

## DESCRIPTION

- A) Lid
- B) Dasher
- C) Removable cylinder
- D) Function selector
- E) Ventilation grille
- F) Hollow to facilitate moving the appliance
- G) Spatula

## IMPORTANT:

- 1) Always close the lid "A" before operating the dasher.
- 2) **Do not leave the selector in the  position for more than 1 minute.**
- 3) After turning the appliance off from " " to " ", always wait at least 5 minutes before turning it on again.
- 4) The appliance must not be laid on its side or turned upside down.

## INSTRUCTIONS



### ASSEMBLY AND DISASSEMBLY

To take the appliance apart, remove the lid, then remove the dasher from the pin in the centre of the cylinder. Then remove the cylinder. To reassemble the appliance, insert the cylinder and press downwards on the edge with the hands (fig. 1). Insert the dasher then fit the lid.

### OPERATION

Assemble the appliance as described in the chapter "ASSEMBLY AND DISASSEMBLY". You are recommended (fig. 3) to moisten the aluminium bottom of the appliance evenly with cotton wool dipped in **alcohol** for food use taking care not to pour it onto the central plastic area (fig. 3). Remember that alcohol is inflammable. You should therefore perform this operation away from flames or hot stoves. This prevents the formation of ice between the cylinder and aluminium bottom of the appliance, making it easier to extract the cylinder when preparation is complete.

Place the ingredients required by the recipe in the cylinder and fit the lid by turning anticlockwise.

Bear in mind that the cylinder holds a maximum of **600 g**. Plug into a suitable mains socket. Make sure there are no obstacles preventing air from circulating freely through the grilles at the sides. Once you have added all the ingredients to the cylinder, turn the appliance on by placing the selector in the   position.

**Important:** never use the appliance without the cylinder. Make sure the outside surface of the cylinder is completely dry before inserting it in the appliance.

Process the ingredients by turning the selector to the required position.

## DESCRIPTION OF SELECTOR

The selector has 4 different positions:

### **Dasher rotation (compressor off)**

Use this function to mix the ingredients during the first phase of ice-cream preparation.

**Important:** you cannot add ingredients to the cylinder while the dasher is in movement.

### **Appliance off.**

### **Chilling (compressor operating)**

Use this function to add or taste ingredients during preparation or to stop the dasher to check the texture of the ice-cream.

If the recipe requires ingredients to be added (pieces of chocolate, raisins, meringues...), turn the selector to the  position for a maximum of 1 minute.

**Important:** you must never leave the appliance in this position for more than 1 minute.

Leaving it in this position for longer could seriously damage the dasher rotation mechanism.

### **Combined dasher rotation and chilling (compressor operating)**

Use this function to make the ice-cream through the combined action of the compressor and the dasher.

When the ice-cream reaches the required texture, place the selector in the  position to turn the appliance off. Normally each ice-cream making cycle lasts about 40 minutes.

Continuous functioning beyond this time will result in excessively hard ice-cream and serious damage to the dasher rotation mechanism.

**Important:** if you need to work the ingredients with a whisk (e.g., to froth the egg whites, beat the eggs and sugar, etc.), you are recommended to prepare the ingredients in a separate container and then pour them into the cylinder.

*You can then select the   function to start making the ice-cream.*

### ONCE THE ICE-CREAM IS READY

When the ice-cream is ready, turn the appliance off by placing the selector in the **O** position.

Remove the lid, the dasher and the cylinder, then use the scoop provided to transfer the ice-cream to another container. Then follow the normal ice-cream preparation procedure, inserting first the cylinder containing the ingredients, then the dasher and finally the lid.

When the ice-cream is ready, turn the appliance off by placing the selector in the **O** position, remove the lid and cylinder and dry the aluminium bottom with a cloth.

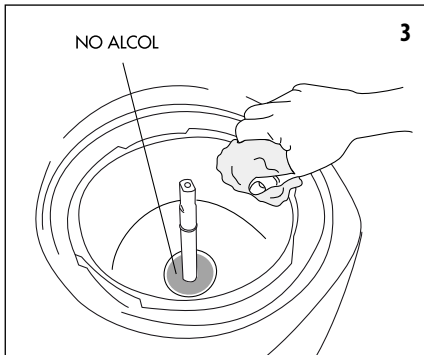

### CLEANING AND TRANSPORT

***Before cleaning, always turn the appliance off by placing the selector in the **O** position and unplug the appliance from the mains socket.***

Always wash the components of the appliance in direct contact with the ingredients thoroughly whenever you use the appliance. Dasher, cylinder and lid can also be washed in the top basket of a dish washer.

You are recommended to use a short low temperature programme.

Dry the bottom of the cylinder thoroughly (fig. 2) before use to avoid ice forming during ice-cream preparation, thus prolonging the ice-cream preparation time.

***The appliance must not be laid on its side or turned upside down.***

