

**Register Now**   
[www.delonghi.com/register](http://www.delonghi.com/register)

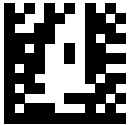

---

EC885

# DEDICA ARTE

COFFEE MAKER  
Instruction for use



---

**DeLonghi**

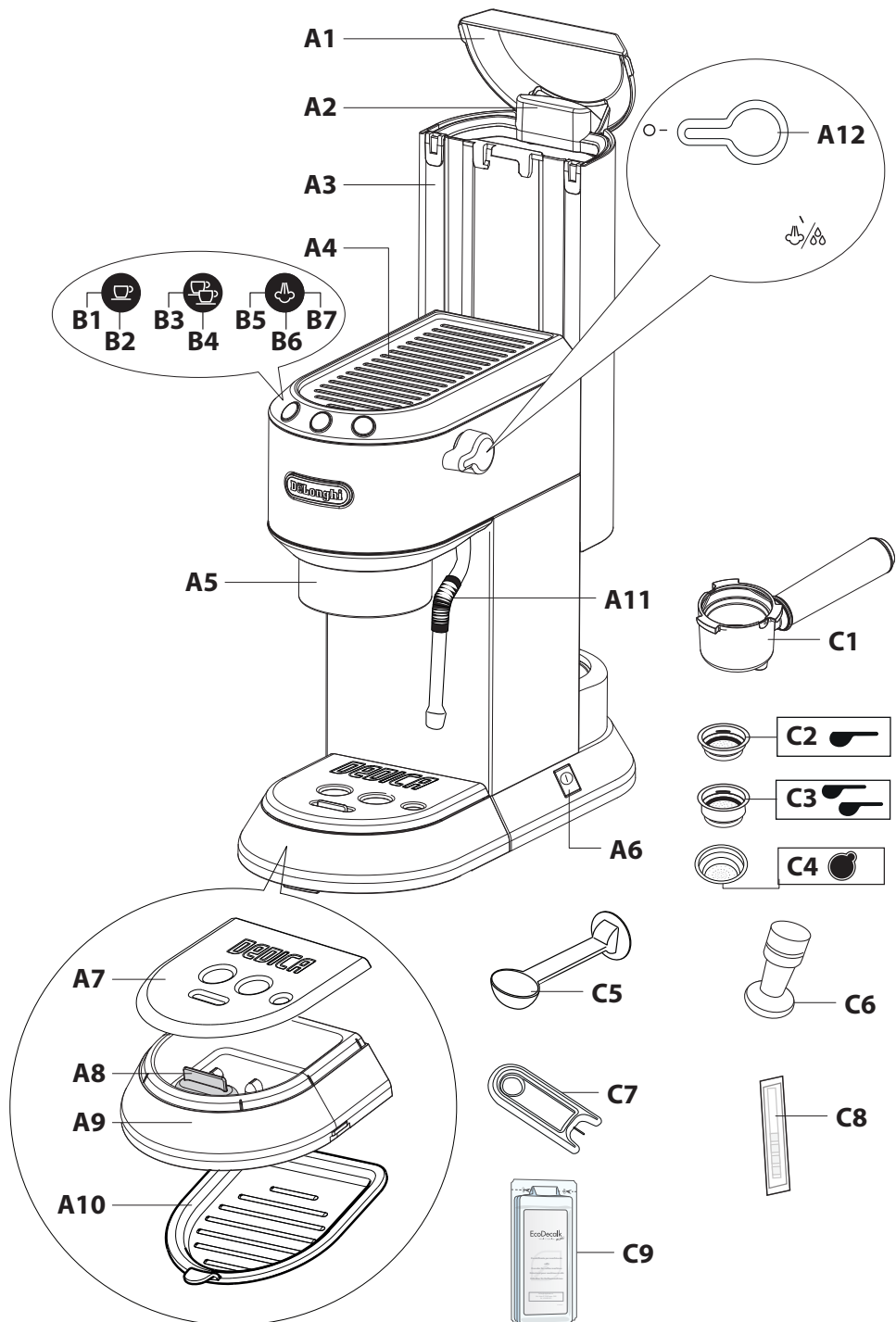

Before using the appliance, always read the safety warnings.

This appliance shall not be used by children.  
Keep the appliance and its cord out of reach of children.

## 1. DESCRIPTION

### 1.1 Description of appliance - A

- A1. Water tank lid
- A2. Tank extraction handle
- A3. Water tank
- A4. Cup warmer
- A5. Coffee outlet
- A6. ON/OFF switch
- A7. Cup tray
- A8. Drip tray full indicator
- A9. Drip tray
- A10. Mugs or glasses tray
- A11. Steam wand
- A12. Steam dial

### 1.2 Description of control panel - B

- B1. One cup button
- B2. ON light on button (white)
- B3. Two cups button
- B4. ON light on button (white)
- B5. Steam button
- B6. ON light on button (white)
- B7. Descaler light (orange)

### 1.3 Description of accessories - C

- C1. Portafilter
- C2. 1 cup filter (☰ symbol under filter)
- C3. 2 cup filter (☷ symbol under filter)
- C4. Pod filter (● symbol under filter)
- C5. Measure/tamper
- C6. Tamper
- C7. Cleaning needle
- C8. Water hardness test
- C9. Descaler

### 1.4 Recommended optional accessories

Visit [Delonghi.com](http://Delonghi.com) for more information.

 **Water hardness filter**  
EAN: 8004399327252

## 2. PREPARING YOUR MACHINE FOR FIRST USE

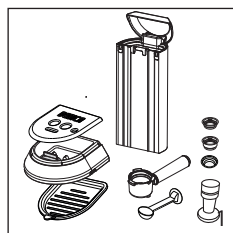

1. Wash and dry all accessories (including water tank (A3)) with warm water and washing-up liquid.

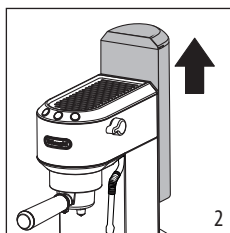

2. Extract the tank by pulling it upwards.

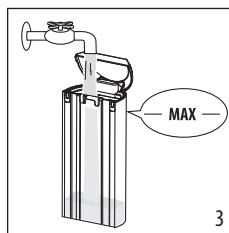

3. Open the lid and fill the tank with fresh clean water, taking care not to exceed the MAX level.

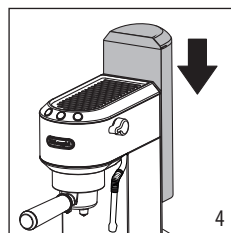

4. Put the tank back in the machine, pressing lightly to open the valves located on the bottom of the tank.



## PREPARING YOUR MACHINE FOR FIRST USE

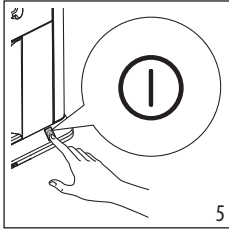

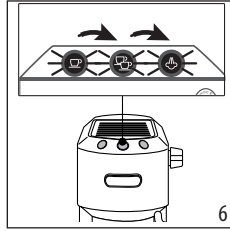

5. Turn the machine on by pressing the ON/OFF switch (A6).

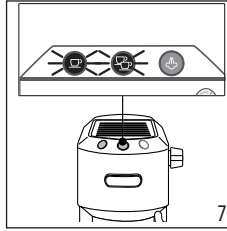

6. The machine performs a self-diagnosis cycle, indicated by sequential flashing of the three buttons.



7. The  and  lights flash to indicate the machine is heating up. When the lights stop flashing and remain on steadily, the machine is ready for rinse.

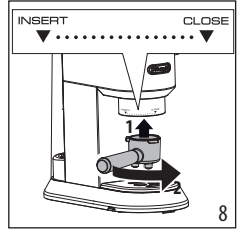

8. Attach the portafilter to the machine aligning the portafilter handle with "INSERT"; then turning the handle to the right until it is aligned in the "CLOSE" position.

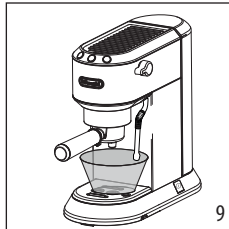

9. Place a container with a minimum capacity of 500 ml under the coffee outlet (A5) and steam wand (A11).

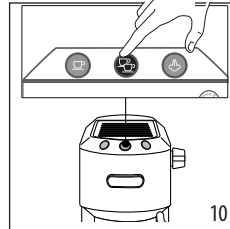

10. Press the  button. Repeat this operation 5 times.

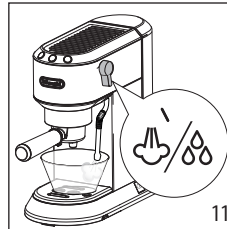

11. Turn the hot water/steam dial to the  position and deliver to empty the water tank; then turn the knob to the 0 position. This is to purge the steam circuit before frothing or steaming your milk.

### Please note:

- Never operate the machine without water in the tank or without the tank.
- It is normal for there to be water in the space under the tank. This should therefore be dried regularly with a clean sponge.

### 3. HOW TO MAKE ESPRESSO COFFEE

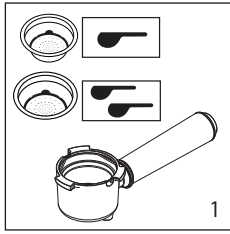

1. Place the ground coffee filter (C2) or (C3) in the portafilter (C1).

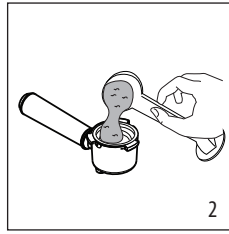

2. Fill the coffee filter with ground coffee. Make sure that you are using a fine grind, specific for espresso.

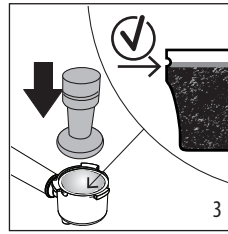

3. Distribute the pre-ground coffee evenly and press with the tamper (C5). Make sure the coffee is at the recommended dose level after tamping. You may need to add some coffee.

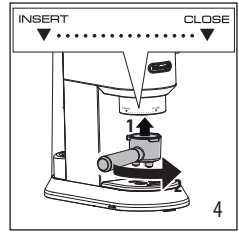

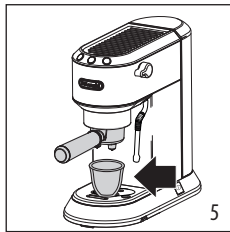

4. Remove any excess coffee from the rim of the portafilter and attach the portafilter to the machine.

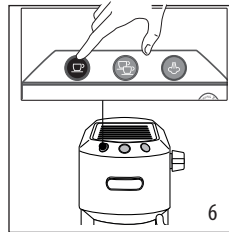

5. Place the cup or cups under the portafilter spouts.



6. Make sure the lights corresponding to the coffee buttons are on, then press the  or  coffee button.

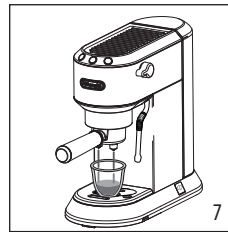

7. The machine proceeds to make the coffee and delivery is interrupted automatically.

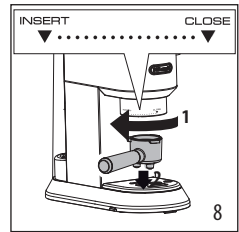

8. To remove the portafilter, turn the handle from right to left.

#### Please note:

- Before filling the coffee filter with pre-ground coffee, make sure there are no coffee residues left in the filter from the last time you made coffee.
- While the machine is making coffee, delivery can be interrupted at any moment by pressing the coffee button pressed previously.
- At the end of delivery (within 3 seconds), to increase the amount of coffee in the cup, press and hold the coffee button pressed previously. Delivery is automatically interrupted after a few seconds.
- To avoid splashes, never remove the portafilter while the machine is delivering coffee. Always wait for a few seconds after delivery.

#### 3.1 Tamping the coffee:

Correct pressing of the pre-ground coffee is essential to obtain a good espresso.

- If you press too firmly, the coffee will be delivered slowly and will be strong.
- If you press too lightly, the coffee will be delivered quickly and will be weak.

#### 3.2 Tips for a hotter coffee

- You are recommended to warm the cups before making coffee by rinsing them with a little hot water.
- Attach the portafilter (C1) to the machine with the filter (C2) or (C3) in place but without adding coffee. Using the same cup as will later be used to make the coffee, press the 1 cup button and deliver hot water into the cup to heat it.
- Raise the infusion temperature in the settings menu (see section "9. Menu settings").
- Rest the cups you will be using on the cup warmer (A4) which becomes hot during operation.

## 4. HOW TO MAKE ESPRESSO COFFEE USING PODS

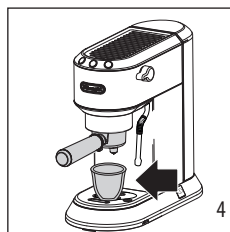
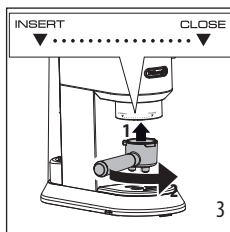
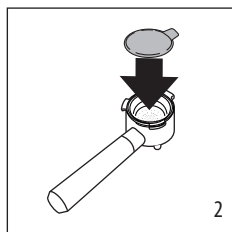
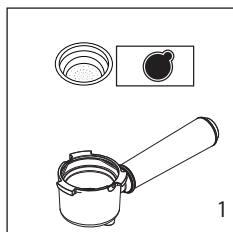

1. Place the filter for coffee pods (C4) in the portafilter.
2. Insert the pod, centring it as far as possible on the filter. Always follow the instructions on the pod pack to position the pod on the filter correctly.
3. Attach the portafilter to the machine.
4. Place the cup under the portafilter spouts.

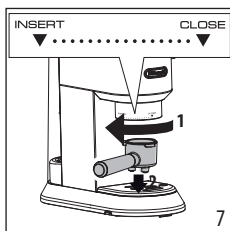
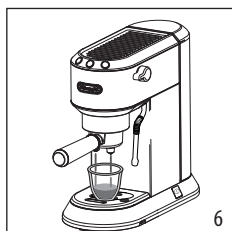
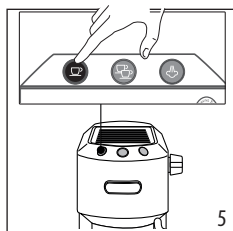

5. Make sure the lights corresponding to the coffee buttons are on, then press the ☕ coffee button.
6. The machine proceeds to make the coffee and delivery is interrupted automatically.
7. To remove the portafilter, turn the handle from right to left.

### 4.1 Choose the pods



Use pods conforming to the ESE standard, indicated on the pack by the corresponding symbol.

The ESE standard is a system accepted by leading pod producers and enables espresso coffee to be prepared simply and cleanly.

#### Please note:

- **When using pods, you can brew 1 cup of coffee only.**
- While the machine is making coffee, delivery can be interrupted at any moment by pressing the coffee button pressed previously.

- At the end of delivery (within 3 seconds), to increase the amount of coffee in the cup, press and hold the coffee button pressed previously. Delivery is automatically interrupted after a few seconds.
- To avoid splashes, never remove the portafilter while the machine is delivering coffee. Always wait for a few seconds after delivery.
- See section "3.2 Tips for a hotter coffee".

## 5. PROGRAMMING THE QUANTITIES OF COFFEE IN THE CUP

The machine is set by default to automatically deliver standard quantities. To change these quantities, proceed as follows:

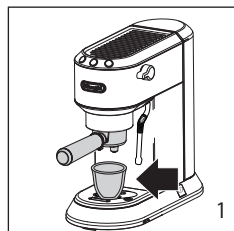

1. Place one or two cups under the portafilter spouts.

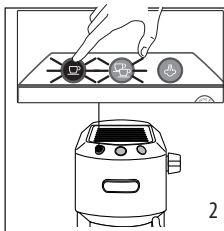

2. Press and hold the button you want to programme (☕ or ☕☕).

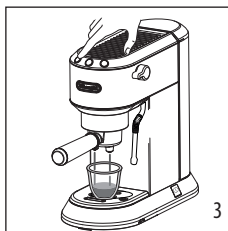

3. The coffee maker starts delivering coffee and the other coffee button flashes to indicate that the machine is in programming mode.

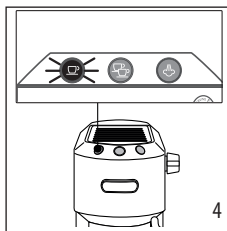

4. Once the required quantity of coffee has been delivered into the cup, release the button. Delivery stops and the light flashes to indicate that the quantity has been saved correctly.

	Default quantity	Programmable quantity
☕	35 ml	from $\approx 15$ to $\approx 90$ ml
☕☕	70 ml	from $\approx 30$ to $\approx 180$ ml

## 6. MAKING CAPPUCCINO

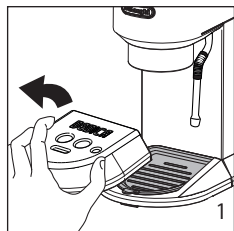

1. To use tall glasses, remove the drip tray (A9) and stand the glasses on the glasses tray (A10)

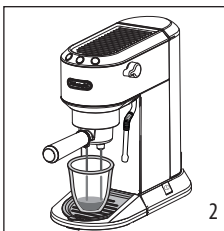

2. Prepare the espresso coffees as described in the previous sections, using sufficiently large cups.

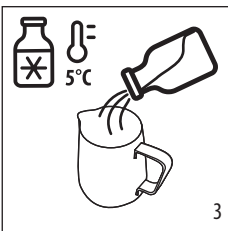

3. Fill a milk pitcher with fresh cold milk. Milk will up to triple in volume.

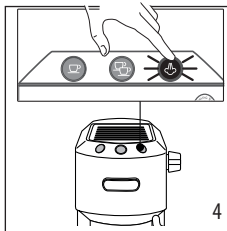

4. Press the ☞ button. The light flashes. When the light comes steady, the appliance is ready to deliver steam.

### Tips for best results:

- Recommended milk quantity for cappuccino: 100 ml.
- For a denser more even froth, you must use milk at refrigerator temperature (about 5°C).
- When steam is ready, before frothing milk, position an empty container under the frother and open the dial for a few seconds to eliminate any air left in the circuit. Close the dial again and proceed.



## MAKING CAPPUCCINO

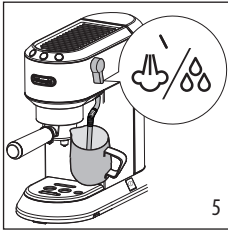

5. Place the recipient containing the milk under the steam wand (A11); immerse the frother and turn the dial to the  position.

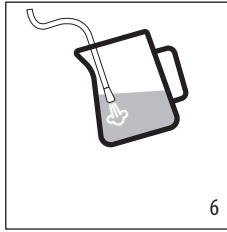

6. To make the froth, put the nozzle on the surface of the milk and air will catch by the mixing of milk and steam.

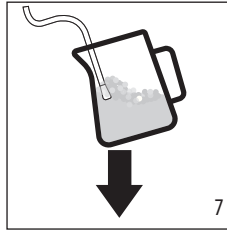



7. Keep the steam nozzle just on the surface, careful not to make big bubbles by letting too much air in.



8. Insert the steam nozzle just under the milk: this create a vortex.

9. Once the desired temperature is reached, turn the steam knob off and wait till steam stops completely before removing the milk pitcher
10. Pour the frothed milk into the cups containing the espresso coffee prepared previously. The cappuccino is ready. Sweeten to taste and if desired, sprinkle the froth with a little cocoa powder.

### Please note:



- To prepare more than one cappuccino, first make all the coffees then at the end prepare the frothed milk for all the cappuccinos.
- To exit the steam function, press any button. The  and  lights flash to indicate that the Cooling Cycle is required.
- You should not deliver steam for more than 60 seconds.

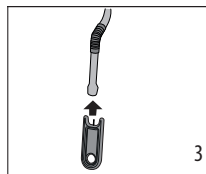
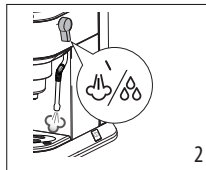
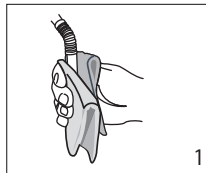

### Cleaning the steam wand

- After every use, remove with a soft damp cloth any milk residues from the steam wand. For perfect cleaning, we recommend Eco Multi-Clean: it ensures hygiene by removing milk proteins and fats and can be used to clean the whole machine.
- Use the steam for a deeper cleaning.
- Wait that the steam wand cool down and open the hole of the nozzle with the cleaning needle (C7).



### 6.1 Cooling Cycle

After having used the steam wand and exited the steam function, the two lights  and  on the front of the machine will flash simultaneously indicating that the boiler needs to be cooled off in order to reach the precise espresso brewing temperature. Simply proceed as follows:

- place a container under the cappuccino maker;
- open the steam dial to deliver steam and hot water: the  light flashes;
  - when both lights ( and ) flash the boiler is cool: close the steam dial. (when the boiler is cool, the pump stops operating and no more water is delivered). The coffee maker is now ready for use.

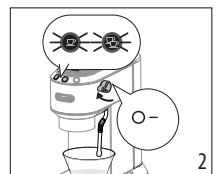

## 7. MAKING HOT WATER



1. Place a container under the steam wand.

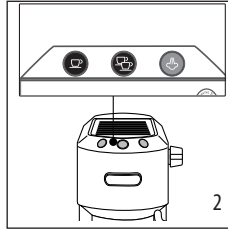

2. Wait for the coffee lights to come on steadily.

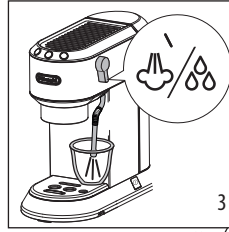

3. Turn the dial to the  position. Hot water is delivered from the steam wand.

You should not deliver hot water for more than 60 seconds.

4. To stop hot water delivery, close the dial.





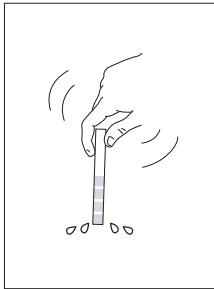
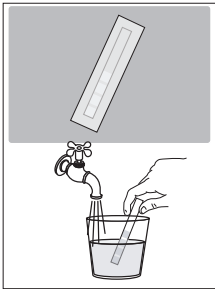

## 8. MEASURING WATER HARDNESS

The descaling alarm is displayed after a period of time established according to water hardness. The machine can also be programmed according to the hardness of the water supply in the various regions, so that descaling is required less often.

- Remove the indicator paper from its packaging.
- Immerse the paper completely in a glass of water for about one second.



3. Remove the strip from the water and shake lightly. After about a minute, 1, 2, 3, or 4 red squares appear, depending on the hardness of the water. Each square corresponds to one level.

Total Hardness Test	Hardness
	Soft
	
	
	Medium
	
	High

See instructions in section "9. Menü settings" to set the machine.

## 9. MENÜ SETTINGS

### 1. Enter the menu

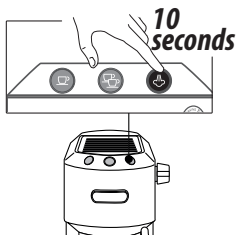

Press and hold the  button for 10 seconds until the three buttons flash in sequence:

...→

## 2. Set the machine

### Infusion temperature

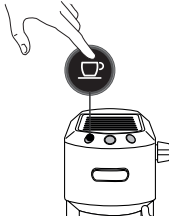

*This temperature refers to the water inside the thermoblock. This differs from the temperature of the beverage in the cup or the temperature measured when the beverage comes out from the portafilter spouts.*

Press  for **Low** temperature

Press  for **Medium** temperature

Press  for **High** temperature

### Water hardness

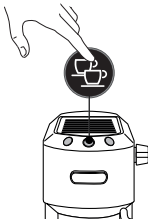

Press  for **Soft** water

Press  for **Medium** water

Press  for **High** water

### Auto-off

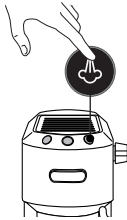

Press  for **9 minutes**

Press  for **30 minutes**

Press  for **3 hours**

## 3. Exit the menu

Exit the settings menu by waiting for 15 seconds.

### **Please note:**

- The setting is automatically confirmed and it is highlighted by a quick flashing of the light relative to the selection.
- If no selections are made for 15 seconds, the machine automatically exits programming and is ready for use again.

## 10. DEFAULT VALUES (RESET)

This resets all menu settings and programmed quantities back to the default values.

To reset the default values, proceed as follows:

1. Position the steam spout over the drip tray;
2. Enter the settings menu;
3. Turn the steam dial to the ☁/☕ position;
4. Press the ☕ button. The three lights flash simultaneously to confirm that the original settings have been restored.
5. The ☕ and ☕ lights flash to indicate that the steam dial must be closed again (○ symbol).

When the steam dial has been closed, the machine is ready for use.

## 11. CLEANING THE MACHINE

The following parts of the machine must be hand cleaned regularly:

- the drip tray (A9)
- the coffee filters (C2), (C3) and (C4);
- the coffee outlet (A5);
- the water tank (A3);
- the steam wand (A11) as described in section "Cleaning the steam wand";

### Important!

- None of the components or accessories is dishwasher safe.
- Do not use solvents, abrasive detergents or alcohol to clean the coffee machine.
- Do not use metal objects to remove encrustations or coffee deposits as they could scratch metal or plastic surfaces.
- If the machine is not used for more than one week, before using it again, we strongly recommend you perform a rinse cycle as described in section "2. Preparing your machine for first use".

### Danger!

- While cleaning, never immerse the coffee maker in water. It is an electrical machine.
- Before cleaning the outside of the machine, turn it off, unplug from the main socket and allow to cool.

### 11.1 Cleaning the drip tray

#### Important!

The drip tray is fitted with a level indicator (red) showing the level of water it contains. Before the indicator protrudes from the cup tray (fig. 1), the drip tray must be emptied and cleaned otherwise the water may overflow the edge and damage the machine, the surface it rests on or the surrounding area.

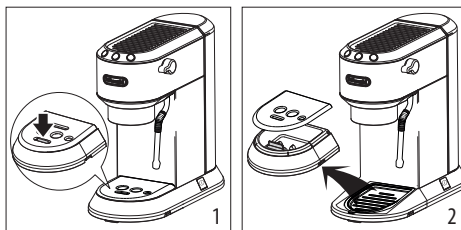

1. Remove the drip tray (A9) (fig. 2).
2. Remove the cup tray (A7), empty the water and clean the drip tray with a cloth, then reassemble the drip tray. Extract the mugs or glasses tray (A10), clean with water, dry and put back in the machine;
3. Put the drip tray back in place.

### 11.2 Cleaning the coffee filters

The coffee filters are designed to obtain the best possible coffee froth. For best results, the filters must always be clean and free from all coffee residues.

After using the appliance, always rinse the filters under abundant running water (fig. 3), pushing the perforated filter to make sure it is always correctly inserted in its housing (fig.4);

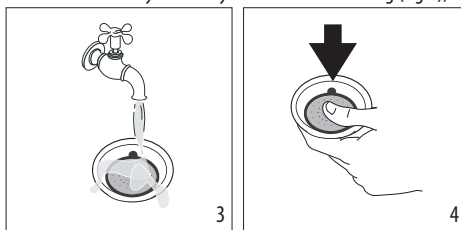

make sure the hole underneath (shown in fig. 5) is free from all residues.

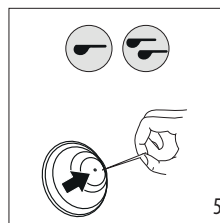

If still dirty, and in any case always at least once a month, clean the coffee filters thoroughly:

1. Extract the perforated filter by pulling the tab (fig. 6).

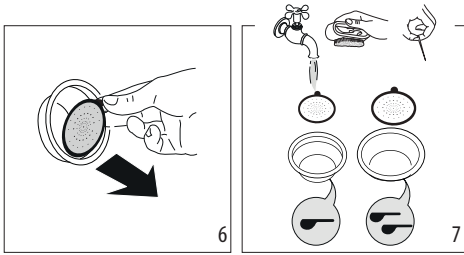

2. Rinse the filters under running water (fig. 7).
3. Make sure the holes are not blocked. If necessary, clean with a pin (fig. 5-7).
4. Dry all the components with a cloth.
5. Put the perforated filter back in the housing and press as far as it will go (fig. 4).

### Pod filter

Rinse under running water. Make sure the holes are not blocked. If necessary, clean with a pin (figs. 8 - 9).

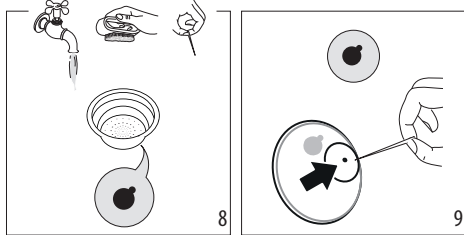

### 11.3 Cleaning the coffee outlet

After every 200 coffees, rinse the coffee outlet by delivering about 0.5 l of water from the coffee outlet (press the coffee button without using ground coffee).

### 11.4 Other cleaning operations

1. Do not use solvents or abrasive detergents to clean the coffee maker. Use a soft damp cloth only.
2. Clean the portafilter cup.

### 11.5 Cleaning the water tank

1. Clean the water tank regularly (about once a month) and whenever you replace the water softener filter (if present) with a damp cloth and a little mild washing up liquid;
2. Remove the filter (if present) and rinse with running water;
3. Put the filter (if provided) back in the machine, fill the tank with fresh water and replace the tank;
4. (If water filter is present)) Deliver about 100 ml of water.

## 12. DESCALING



### Please note

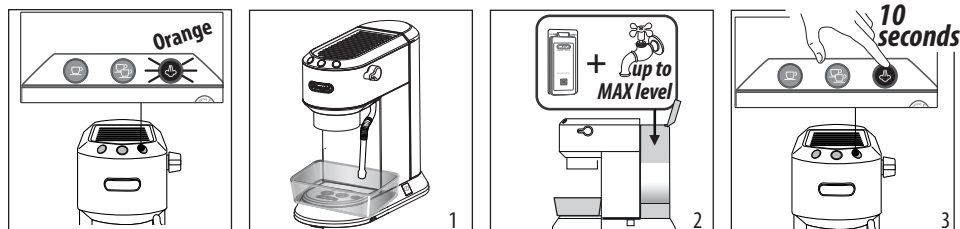

- Before use, read the instructions and the labelling on the descaler pack.
- It is important to use De'Longhi descaler only. Using unsuitable descaler and/or performing descaling incorrectly may result in faults not covered by the manufacturer's guarantee.
- Descaler could damage delicate surfaces. If the product is accidentally spilt, dry immediately.
- IF PRESENT, REMOVE THE WATER SOFTENER FILTER.

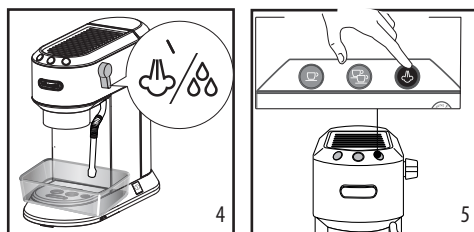

Descal the machine when the orange light on the  button flashes.

1. Make sure the portafilter is not attached and position a recipient under the hot water spout and coffee outlet
2. Fill the tank with the descaler solution, obtained by diluting the descaler provided with water (fill the water tank up to the MAX level).
3. Press and hold the  button for 10 seconds until the three buttons flash in sequence.



4. Turn the steam dial to the  position.
5. Press the  button to start descaling

6. The descale programme starts and the descaler liquid comes out of the steam wand and coffee outlet. The descale programme removes limescale deposits from inside the appliance by automatically performing a series of rinses and pauses until the tank is empty.

### Please note:





During descaling, to clean the coffee outlet, **close the steam dial from time to time** to deliver small quantities of descaler from the coffee outlet.

Delivery stops and the orange  light continues to flash, indicating that descaling is still underway. This indicates that it is necessary to proceed with rinsing: see next steps.

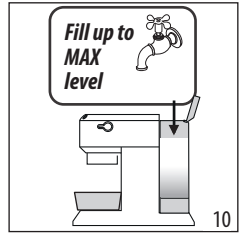
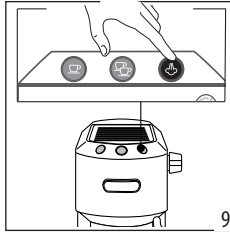
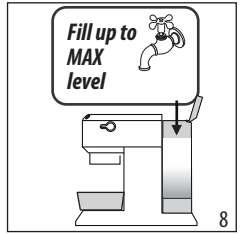
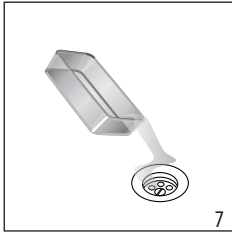







## DESCALING



7. Empty the recipient used to collect the descaler solution and replace it empty.
  8. The machine is now ready for rinsing through with clean water. Extract the water tank, empty, rinse under running water, fill with fresh water up to the MAX level and put back in the machine.
  9. Make sure the steam dial is in the  position, then press the  button to start rinsing. During rinsing, to clean the coffee outlet, **close the steam dial from time to time** to deliver small quantities of water from the coffee outlet.
  10. Make a second rinse from step 7 to 9 inserting the water filter hardness (if previously installed).
  11. When the water tank is empty, the orange light goes out and descaling is complete. The  and  lights flash.
  12. Close the steam dial turning it to 0 position.
  13. Fill the water tank with fresh water.
- Now the appliance is ready to use.

### 13. EXPLANATION OF LIGHTS

Lights	Operation	Explanation of lights
	The ON/OFF button is turned on	The machine performs a self-diagnosis cycle, indicated by sequential flashing of the lights
	When the machine is turned on	Flashing lights: the machine is heating up to make coffee Lights on steadily: the machine is ready to make coffee
	Steam dial open	Flashing lights: close the steam dial
	Cleaning & Cooling Cycle required	Activate the Cleaning & Cooling Cycle as described in section "6.1 Cooling Cycle".
→		

Lights	Operation	Explanation of lights
	The tank is empty or the machine will not make coffee	The lights flash rapidly. See the section "2. Preparing your machine for first use"
	The steam function is required	Flashing light: the machine is heating up to deliver steam Light on steadily: the machine is ready to deliver steam
 <i>orange flashing</i>	The machine needs descaling	Descalc the machine, the operation is complete when the  light goes off.

## 14. TROUBLESHOOTING

Problem	Cause	Solution
No espresso coffee is delivered	No water in the tank	Fill the tank
	The holes in the portafilter are blocked	Clean the portafilter spout holes
	The filter is blocked or the perforated filter is missing	Clean as described in section "11.2 Cleaning the coffee filters"
	The tank has been inserted incorrectly and the valves on the bottom are not open	Press the tank down lightly to open the valves on the bottom
	Limescale in the water circuit	Descalc as described in section "12. Descaling"
The espresso coffee drips from the edges of the portafilter rather than the holes	The portafilter has been inserted incorrectly or is dirty	Attach the portafilter correctly and rotate firmly as far as it will go
	The espresso boiler gasket has lost elasticity or is dirty	Have the espresso boiler gasket replaced by Customer Services
	The holes in the portafilter spouts are blocked	Clean the portafilter spout holes
	The filter is blocked or the perforated filter is missing	Clean as described in section "11.2 Cleaning the coffee filters"
The portafilter cannot be attached to the machine	Too much coffee has been placed in the filter	Use the measure supplied and make sure you are using the correct filter for the type of preparation
		→



<b>Problem</b>	<b>Cause</b>	<b>Solution</b>
The coffee froth is too light (delivered from the spout too fast)	The pre-ground coffee is not pressed down firmly enough	Press the pre-ground coffee more firmly
	There is not enough pre-ground coffee	Increase the quantity of pre-ground coffee
	The pre-ground coffee is too coarse	Use only pre-ground coffee for espresso coffee makers
	The wrong type of pre-ground coffee is being used	Change the type of pre-ground coffee
The coffee froth is too dark (delivered from the spout too slowly)	The pre-ground coffee is pressed down too firmly	Press the coffee down less firmly
	There is not enough pre-ground coffee	Reduce the quantity of pre-ground coffee
	The espresso coffee outlet is blocked	Clean as described in section "11.3 Cleaning the coffee outlet"
	The filter is blocked	Clean as described in section "11.2 Cleaning the coffee filters"
	The pre-ground coffee is too fine	Use only pre-ground coffee for espresso coffee makers
	The pre-ground coffee is too fine or damp	Use pre-ground coffee for espresso coffee makers only and make sure it is not too damp
Limescale in the water circuit	Descal as described in section "12. Descaling"	
After delivering coffee, the filter remains attached to the coffee outlet		Insert the portafilter again, deliver coffee, then remove the portafilter
The machine will not make any drink and all the lights flash for a few seconds	No water in the tank	Fill the tank with water
	The tank has been inserted incorrectly and the valves on the bottom are not open	Press the tank down lightly to open the valves on the bottom
	The espresso coffee outlet is blocked	Clean as described in section "11.3 Cleaning the coffee outlet"
	The filter is blocked	Clean as described in section "11.2 Cleaning the coffee filters"
	Limescale in the water circuit	Descal as described in section "12. Descaling"
The machine does not function and all the lights flash		Disconnect the machine immediately and contact authorised Customer Services.
No milk froth is formed when making cappuccino	Milk not cold enough	Always use milk at refrigerator temperature
	Frother dirty	Clean as described in section "Cleaning the steam wand"
	Limescale in the water circuit	Descal as described in section "12. Descaling"