

Before using the appliance, always read the safety warnings.

**This appliance shall not be used by children.
Keep the appliance and its cord out of reach
of children.**

1. DESCRIPTION

1.1 Description of the appliance

(page 3 - A)

- A1. Beans container lid
- A2. Beans container
- A3. Cup tray
- A4. Steam dial
- A5. Hot water spout
- A6. Steam spout
- A7. Cappuccino maker selection ring
- A8. Cappuccino maker
- A9. Cappuccino maker connection nozzle
- A10. Cup grille for espresso
- A11. Cup grille for glasses or mugs
- A12. Drip tray grille
- A13. Drip tray
- A14. Drip tray water level indicator
- A15. Water tank lid
- A16. Water tank extraction handle
- A17. Water tank
- A18. Water softener filter housing
- A19. Power cord connector socket
- A20. Main switch (ON/OFF)
- A21. Boiler outlet
- A22. Coffee mill outlet (tamping station)
- A23. Presser lever

1.2 Description of control panel

(page 3 - B)

- B1. ON/Standby button
- B2. Ground coffee quantity dial
- B3. "X2" button: to use the 2 coffees Easy Clean filter
- B4. Rinse button
- B5. "OK" button: to deliver the beverage/confirm
- B6. Hot water button
- B7. "My" button: to customise beverage quantity
- B8. Mode selector dial:
 - Espresso
 - Americano
 - Coffee
 - Descaling
- B9. Descale light
- B10. Steam ready light
- B11. Overttemperature light

- B12. Energy saving light
- B13. General alarm light
- B14. Beans container empty/No beans container light
- B15. No water light
- B16. Pressing light
- B17. Pressure gauge

1.3 Description of the accessories

(page 2 - C)

- C1. Filter holder
- C2. Easy Clean filter 1 coffee
- C3. Easy Clean filter 2 coffee
- C4. "Total Hardness Test" indicator paper
- C5. Descaler
- C6. Water softener filter (*if present)
- C7. Power cord
- C8. Tube brush
- C9. Milk jug

2. PREPARING THE APPLIANCE



Wash all accessories with warm water and washing-up liquid, then proceed as follows:

1. Insert the beans container (A2) in the coffee mill (fig. 1). The container is correctly inserted when the arrow is lined up with the  symbol and you hear a "click";
2. Insert the drip tray (A13) complete with cup grill (A11) and drip tray grille (A12) (fig. 2);
3. Extract the water tank (A17) (fig. 3) and fill with fresh clean water, taking care not to exceed the MAX level (fig. 4).
4. Put the tank back in the appliance.

Important: Never operate the appliance without water in the tank or without the tank.

Please note: You should customise water hardness as soon as possible following the instructions in section "12.2 Water hardness".

3. SETTING UP THE APPLIANCE

1. Plug the power cord connector (C7) into the socket (A19) at the back of the appliance (fig. 5), then plug the plug into the mains socket. Make sure the main switch (A20) at the back of the appliance is pressed and in the **I** position (fig. 6);
2. The  light corresponding to the button (B6) comes on to indicate that you need to deliver water to fill the circuit (fig. 7);
3. Place a container with a minimum capacity of 100 ml under the hot water spout (A5) and cappuccino maker (A8) (fig. 8);
4. Press the button (B6) corresponding to the  light (fig. 9). Delivery begins and stops automatically. Empty the container.

Before using the machine, you must rinse the internal circuits. Proceed as follows:

- Attach the filter holder (C1) complete with filter to the appliance. To attach correctly, align the filter holder handle with "INSERT" (fig. 10), then turn the handle to the right until it is aligned in the "CLOSE" position;
- Place a recipient under the filter holder and cappuccino maker (A8) (fig. 11);
- Press the button (B4) corresponding to the  light. Delivery begins (fig. 12);
- When delivery is complete, turn the steam dial (A4) (fig. 13) and deliver steam for 10 seconds to rinse the steam circuit;
- Repeat points 7 and 8 until you have delivered at least 1 litre of water (about half the tank);
- Extract the water tank (A17) (fig. 3), rinse and fill with fresh clean water, taking care not to exceed the MAX level (fig. 4).

The appliance is ready for use.

Please note: *We also recommend rinsing the internal circuits if the appliance is not used for a long period.*

The first time you use the appliance, you need to make 4-5 cups of coffee before the appliance starts to give satisfactory results. Pay particular attention to the quantity of pre-ground coffee in the filter ((C2) or (C3)) (see instructions in section "4.5 Adjusting the quantity of ground coffee in the filter").

Proceed as described in section "4. Prepare the perfect dose".

4. PREPARE THE PERFECT DOSE

4.1 Preparing the coffee mill

- Make sure the beans container is correctly inserted and lined up to position "3" (fig. 14) (default setting);
- Remove the beans container lid (A1);
- Place the required quantity of coffee beans in the container (fig. 15);
- Close the lid, pressing firmly.
- The first time you use the appliance, make sure the dial (B2) is in the  position (default setting).

4.2 Select the grinding level

The grinding level affects delivery speed and therefore the quality of the extract.

The first time you use the appliance, we recommend using the factory setting (medium grinding) (fig. 14), then if you are not satisfied with the result, adjust the level according to your personal taste and the type of coffee by setting a finer or coarser grinding level, referring to the tips in section "4.5 Adjusting the quantity of ground coffee in the filter".

Important:

- Always adjust the coffee mill while in operation.*
- Adjust one grinding level at a time and make at least 5 coffees before adjusting again.*
- Do not remove the beans container while it contains beans.*

4.3 The coffee filters

The appliance is provided with two coffee filters.

The 1 coffee filter (C2) has the  symbol marked on the bottom.



The 2 coffee filter (C3) has the  symbol marked on the bottom.

For the correct quantity of coffee, the ideal level of pressed coffee is marked inside the filters (fig. 16). If the quantity is above or below the level indicated, the result may not be satisfactory. The next times you use the coffee mill, you can adjust the grinding level using the dial (B2) (see section "4.5 Adjusting the quantity of ground coffee in the filter").



4.4 Grind the coffee directly into the filter

- Place the ground coffee filter (C2) or (C3) in the filter holder (C1) (fig. 17);
- Press the "X2" button if you are using the 2 coffee filter;
- Attach the filter holder to the outlet of the coffee mill (A22), aligning it with "INSERT", then turning it to the right (fig. 18). Grinding begins when the filter holder reaches the CLOSE position and stops automatically;

Important: *while the appliance is grinding coffee, you can perform a rinse, or produce hot water or steam at the same time.*

- Once grinding is complete, the  light (B16) flashes. Pull the presser lever (A23) as far as it will go. The force exerted on the coffee is indicated on the lever itself ( (fig. 19).
- Remove the filter holder by turning it towards the left.

Important: *to adjust the correct quantity ground automatically into the filter holder, see section "4.5 Adjusting the quantity of ground coffee in the filter".*

If you remove the filter holder from the outlet of the coffee mill without pressing the coffee, the  light (B16) flashes. To press, turn the dial (B2) to the  position to disable the coffee mill, re-attach the filter holder and pull the lever (A23).

4.5 Adjusting the quantity of ground coffee in the filter

Important: *The first time you use the coffee mill, leave the dial in the  position (min). It is normal for you to have to grind the coffee a number of times before finding the correct adjustment for the right amount of coffee.*

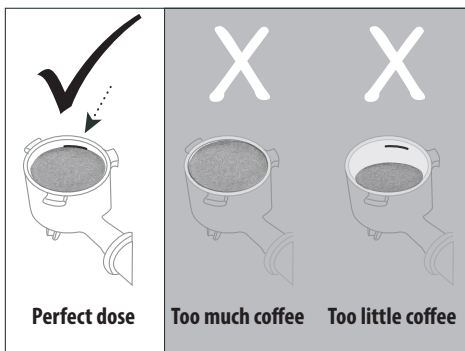

After grinding coffee for the first time, turn the dial (B2) gradually, starting from the "min" position (see following figure) until you reach the correct quantity, depending on the type of coffee. The ideal position is within the sector shown in grey in the following figure.

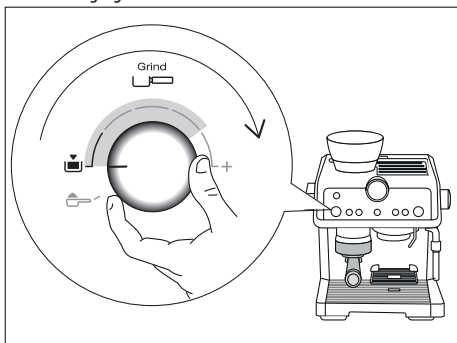

By adjusting this dial, you can adapt the mill to any type of coffee and to wear of the burrs over time.

5. COFFEE DELIVERY

5.1 Beverage selection

1. Turn the mode selector dial (B8) to select the desired coffee (see section "5.4 Coffee beverages").
2. If you use the 2 cup filter (C3), press the "2X" button (B3).

5.2 Delivering the coffee

1. Attach the filter holder (C1) to the appliance. To attach correctly, align the filter holder handle with "INSERT" (fig. 10), then turn the handle to the right until it is aligned in the "CLOSE" position;
2. Place the cup or cups under the filter holder spouts;
3. If you are using small cups, lower the cup grille (A10) to bring the filter holder spouts nearer the cup. This makes a better froth (fig. 20);
4. Using the dial (B8), select the desired beverage.

5. Press the button. The appliance makes the coffee then stops automatically.

Please note: While the machine is making coffee, delivery can be interrupted at any moment by pressing the button. To remove the filter holder, turn the handle from right to left.

Danger of burns

- To avoid splashes, never remove the filter holder while the appliance is delivering coffee. Wait for a few seconds after delivery.
- If no coffee is delivered, wait for about 1 minute before removing the filter holder. There could be a puff of steam caused by the residual pressure inside the appliance.

5.3 Pressure gauge

The pressure gauge enables you to check that pressure is correct while the coffee is being delivered (fig. 21).

While making Espresso coffee, the indicator of the pressure gauge will rotate within the optimal zone sector showing the pressure used during brewing.

For more information, see section "16. How to make perfect coffee".

Important: the pressure gauge only operates while coffee beverages are being made. If you are preparing hot water " " or using the steam function, the pressure gauge indicator does not move.

5.4 Coffee beverages

• ESPRESSO





Beverage of Italian origin, a short coffee with an intense aroma.

Coffee	Pre-infusion	Quantity	Filter	×2
Espresso 	✓	1 cup 35 ml		
		2 cups 70 ml		✓

Always check that there is the right amount of coffee in the filter (see section "4.5 Adjusting the quantity of ground coffee in the filter").

• COFFEE





Beverage of European origin, a long coffee with a delicate aroma.

Coffee	Pre-infusion	Quantity	Filter	x2
Coffee 	X	1 cup 70 ml	C2  	X
		2 cups 140 ml	C3  	✓

Always check that there is the right amount of coffee in the filter (see section "4.5 Adjusting the quantity of ground coffee in the filter").

• AMERICANO

Beverage of American origin, a long coffee. Made by delivering an espresso, followed by hot water added directly to the cup. Only one cup can be made at a time.

Coffee	Pre-infusion	Quantity	Filter	x2
Americano 	✓	1 cup 120 ml	C2  	X
		RECOMMENDED:		
		1 cup 240 ml	C3  	✓

Always check that there is the right amount of coffee in the filter (see section "4.5 Adjusting the quantity of ground coffee in the filter").

6. CUSTOMISING THE QUANTITY OF COFFEE BEVERAGES WITH THE (my) BUTTON (B7)

- Prepare the appliance to deliver 1 or 2 cups of the coffee beverage you want to make, as far as attaching the filter holder (C1) complete with the (C2) or (C3) filter and ground coffee.
- Turn the dial (B8) to select the coffee to be programmed.
- Press the (my) button: the light corresponding to the (OK) button (B5) comes on steadily and the light corresponding to the (my) button flashes.
- Press the (OK) button to start delivering the beverage. The lights corresponding to the (OK) and (my) buttons flash.
- When you have reached the desired quantity of the beverage, press the (OK) button again.

- Press the (my) button to save the new setting. The appliance is ready for use again and the (my) button remains on. If you do not want to save the new setting, press any other button.

Programming Americano coffee: follow the procedure described above for the quantities of both coffee and hot water.

Please note:

- You can programme coffee beverages, but not steam and hot water.
- Programming changes the quantity of the beverages, but not the amount of coffee ground.
- "X2" beverages can be programmed separately.

6.1 Beverage reset (my)

To reset the default beverage quantities, press and hold the (my) button (B7) until it goes off.

The selected beverage is reset to the default values.

7. USING PRE-GROUND COFFEE



- Place the ground coffee filter (C2) or (C3) in the filter holder (C1) (fig. 17);
- Place the quantity of ground coffee in the filter;
- Turn the dial (B2) to the ☞ position to disable the coffee mill;
- Attach the filter holder to the outlet of the coffee mill (A22), aligning it with "INSERT", then turning it to the right (fig. 10).
- Pull the presser lever (A23) as far as it will go. The printing on the lever indicates the pressing force exerted () (fig. 19).
- Remove the filter holder by turning it towards the left.



8. DELIVERING HOT WATER

- Choose the cup and place it on the correct cup grille ((A10) or (A11)).
- Press the (H₂O) button (B6): the appliance delivers hot water from the spout (A5) then goes off automatically.
- To interrupt delivery, press the (H₂O) button again.

9. HOW TO MAKE MILK-BASED BEVERAGES

- Pour the quantity of milk you want to heat/froth into the milk jug (C9), remembering that the volume of milk doubles or triples in volume. For a denser more even froth, you should ideally use skimmed or partially skimmed cow's milk at refrigerator temperature (about 5°C).
- Choose the position of the ring (A7) (fig. 22) according to the beverage to be prepared (see following table):

Recommended position	Milk beverage to be prepared
FLAT 	Hot milk (not frothed) / Caffelatte / Macchiato / Flat White
FOAM 	Cappuccino, Espresso Macchiato, Hot Milk (frothed)

- Place the jug (C9) containing the milk under the cappuccino maker (A8) (fig. 23).
- Immerse the cappuccino maker in the milk jug. Never immerse the black ring (fig. 24).
- Turn the dial to the  position (fig. 25). Steam to heat the milk is delivered from the cappuccino maker. If the ring is in the FOAM position, the steam gives the milk a creamy frothy appearance (fig. 26). To obtain a creamier froth, immerse the cappuccino maker in the milk and rotate the container with slow upward movements.
- When the required temperature (the ideal is 60°C) and froth density is reached, interrupt steam delivery by turning the dial to the  position.
- For beverages requiring it, prepare the coffee (see section "4. Prepare the perfect dose"). Choose sufficiently large cups and place them on the espresso cup grille (A10). To use tall glasses, close the espresso cup grille (A10) and rest the glass on the cup grille for glasses or mugs (A11).
- Pour the frothed milk into the cups. Sweeten to taste and if desired, sprinkle the froth with a little cocoa powder.

Please note: Preparing cappuccino: consider about 100 g of milk for each cup.

10. CLEANING THE CAPPUCCINO MAKER AFTER USE

For hygiene reasons, the cappuccino maker should always be cleaned after use.

Proceed as follows:

- Turn the steam dial to the  position to deliver a little steam for a few seconds (points 2, 5 and 6 of the previous section). This causes the cappuccino maker to discharge any milk left inside.
- Press the (B1) ON/Standby button to turn the appliance off.
- Wait a few minutes for the cappuccino maker to cool down. With one hand, hold the cappuccino maker tube firmly, with the other, release the cappuccino maker by turning it anticlockwise, then pull off downwards (fig. 27).
- Remove the rubber steam connection nozzle from the spout by pulling it downwards (fig. 28).
- Push the ring upwards and make sure the two holes shown by the arrows in fig. 29 are not blocked. If necessary, clean with a pin;

- Replace the connection nozzle, move the ring downwards and put the cappuccino maker back on the nozzle, turning it and pushing it upwards until it is attached.
For more thorough cleaning, use De'Longhi detergent.

11. ACTIVATING THE WATER SOFTENER FILTER

Certain models are fitted with a water softener filter (C6). If this is not the case with your model, you are recommended to purchase one from De'Longhi Customer Services.

To use the filter correctly, follow the instructions below.

- Remove the filter from the packaging;
- Turn the date indicator disk (fig. 30) until the next 2 months of use are displayed;

Please note: The filter lasts about two months if the appliance is used normally. If the coffee machine is left unused with the filter installed, it will last a maximum of 3 weeks.

- To activate the filter, run tap water through the hole in the filter (fig. 31) until water comes out of the openings at the side for more than a minute;
- Extract the tank (A17) (if necessary fill with water);
- Insert the filter in the water tank and immerse it completely for about ten seconds, sloping it and pressing it lightly to enable the air bubbles to escape (fig. 32);
- Place the filter in the filter housing (A18) and press as far as it will go. Close the tank, then put the tank back in the machine;





The filter is now active and you can use the coffee machine.

12. MENU SETTINGS

Please note: Once in the menu, you can modify all the menu functions as described in the previous sections.

12.1 Coffee temperature

To change the temperature of the water used to make the coffee, proceed as follows:

- Press and hold the $\times 2$ (B3) and  (B7) buttons together for at least 3 seconds to access the menu. The  (B15) and  (B16) lights alternate;
- Turn the mode selection dial (B8) to the  ESPRESSO position. The  light (B11) remains on steadily;
- Press the button corresponding to the desired selection as shown in the following table:





Button	Temperature
$\times 2$	Standard
	High







- Press the  button (B1) to exit the menu. (If the appliance is left idle for about 1 minute, it exits automatically from the settings menu and is ready for use again).

12.2 Water hardness

The  descale light (B9) comes on after a period of time established according to water hardness. The machine can also be programmed according to the actual hardness of the water supply in the various regions, in which case descaling may be required less frequently.

Proceed as follows:





1. Remove the "TOTAL HARDNESS TEST" indicator paper (C4) from its pack.
2. Immerse the paper completely in a glass of water for one second.
3. Remove the paper from the water and shake lightly. After about a minute, 1, 2, 3, or 4 red squares form, depending on the hardness of the water. Each square corresponds to one level.
4. Press and hold the $\times 2$ (B3) and  (B7) buttons for at least 3 seconds to access the menu. The  (B15) and  (B16) lights alternate;
5. Turn the mode selection dial (B8) to the  AMERICANO position. The  light (B9) remains on steadily;
6. Press the button corresponding to the desired selection as shown in the following table:



Total Hardness Test result	Button	Level
	$\times 2$	1 soft water
		2 medium water
		3 hard or very hard water
		

7. Press the  button (B1) to exit the menu. (If the appliance is left idle for about 1 minute, it exits automatically from the settings menu and is ready for use again).

12.3 Auto-off

Auto-off can be set so that the appliance goes off after 9 minutes, one and a half hours, or three hours. Proceed as follows:



1. Press and hold the $\times 2$ (B3) and  (B7) buttons for at least 3 seconds to access the menu. The  (B15) and  (B16) lights alternate;
2. Turn the mode selector dial (B8) to the  COFFEE position: The  light (B13) remains on steadily;
3. Press the button corresponding to the desired selection as shown in the following table:

Button	Time
$\times 2$	9 minutes
	1.5 hours
	3 hours

4. Press the  button (B1) to exit the menu. (If the appliance is left idle for about 1 minute, it exits automatically from the settings menu and is ready for use again).

12.4 Default values



The appliance can be reset to the default values. Proceed as follows:

1. Press and hold the $\times 2$ (B3) and  (B7) buttons for at least 3 seconds to access the menu;
2. Press and hold the  button for a few seconds until the corresponding light starts flashing;
3. Press the  button (B1) to exit the menu. (If the appliance is left idle for about 1 minute, it exits automatically from the settings menu and is ready for use again).

12.5 Energy saving

Use this function to enable or disable energy saving. When enabled, the function reduces energy consumption in compliance with European regulations.

Proceed as follows:







1. Press and hold the $\times 2$ (B3) and  (B7) buttons for at least 3 seconds to access the menu;
2. Press the  button (B6). The light (B12) comes on ;
3. Press the  button (B1) to exit the menu. (If the appliance is left idle for about 1 minute, it exits automatically from the settings menu and is ready for use again).



Please note:

- If energy saving is active, you may have to wait a few seconds before delivery.
- When energy saving is disabled, steam is delivered immediately.

12.6 Extra grinding adjustment

Over time, the burrs will wear down and the quantity of ground coffee will diminish. When adjusting the burrs as described in section "4.5 Adjusting the quantity of ground coffee in the filter" is no longer enough, you can select a new grinding range. Proceed as follows:

1. Press and hold the $\times 2$ (B3) and  (B7) buttons for at least 3 seconds to access the menu. The  (B15) and  (B16) lights alternate;
2. Turn the mode selection dial (B8) to the  position. The  light (B14) remains on steadily;
3. Select the new grinding range by pressing the  button (B4);

- Press the  button (B1) to exit the menu. (If the appliance is left idle for about 1 minute, it exits automatically from the settings menu and is ready for use again);
- Turn the ground coffee quantity dial (B2) to the  "min" position, then proceed to adjust as if it were the first time ("4.5 Adjusting the quantity of ground coffee in the filter").

13. CLEANING

13.1 Cleaning the machine

The following parts of the machine must be cleaned regularly:

- drip tray (A13) complete with cup grille (A11) and drip tray grille (A12);
- espresso cup grille (A10);
- coffee filters (C2) and (C3);
- the beans container (A2);
- the coffee mill burrs;
- the coffee mill outlet (A22) (smart tamping station);
- boiler outlet (A21);
- water tank (A17);
- cappuccino maker (A8) as described in section "10. Cleaning the cappuccino maker after use".

Important!

- Do not use solvents, abrasive detergents or alcohol to clean the coffee machine.
- Do not use metal objects to remove encrustations or coffee deposits as they could scratch metal or plastic surfaces.
- None of the components of the appliance can be washed in a dishwasher with the exception of the drip tray (A13) and cup grilles (A10) and (A11).
- If the appliance is not used for more than a week, before using it again, we recommend you perform a rinse cycle as described in section "3. Setting up the appliance".

Danger!

- While cleaning, never immerse the coffee maker in water. It is an electrical appliance.
- Before cleaning the outside of the appliance, turn it off, unplug from the mains socket and allow to cool.

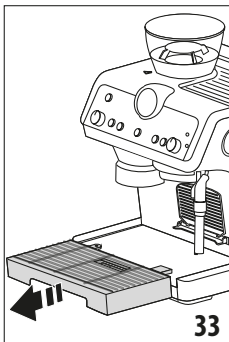

13.2 Cleaning the drip tray

The drip tray is fitted with a level indicator (A14) showing the amount of water it contains. Before the indicator protrudes from the cup tray, the drip tray must be emptied and cleaned, otherwise the water may over-

flow the edge and damage the appliance, the surface it rests on or the surrounding area.

- Remove the drip tray (fig. 33).
- Remove the cup grille (A11), drip tray grille (A12) and level indicator (A14), empty the water and clean all the components with a cloth, then reassemble the drip tray.
- Put the drip tray back in place.

13.3 Cleaning the espresso cup grille

- Extract the grille (A10) by pulling it from the left, then removing it from the support (fig. 34).
- Clean the support with a cloth and wash the grille (dishwasher safe).
- Put the grille back on the support from the right side, then push until it is correctly attached (fig. 35).

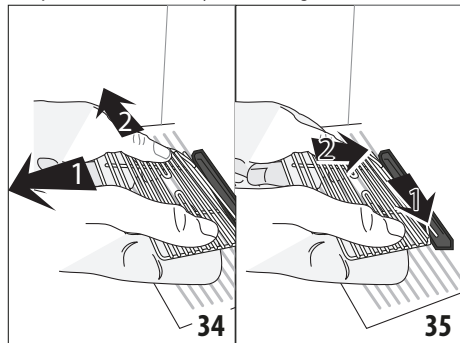

13.4 Coffee filter cleaning and maintenance

The coffee filters are designed to obtain the best possible coffee froth. For best results, the filters must always be clean and free from all coffee residues.

After using the appliance, always rinse the filters under abundant running water (fig. 36), pushing the perforated filter to make sure it is always correctly inserted in its housing (fig. 37); make sure the hole underneath (shown in fig. 40) is free from all residues.

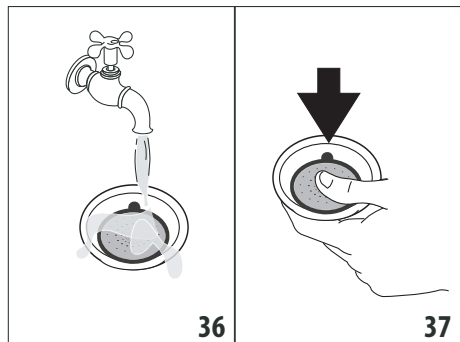

If still dirty, and in any case always at least once a month, clean the coffee filters thoroughly:

1. Extract the perforated filter by pulling the tab (fig. 38).

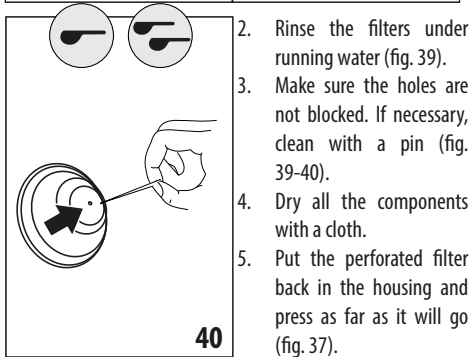
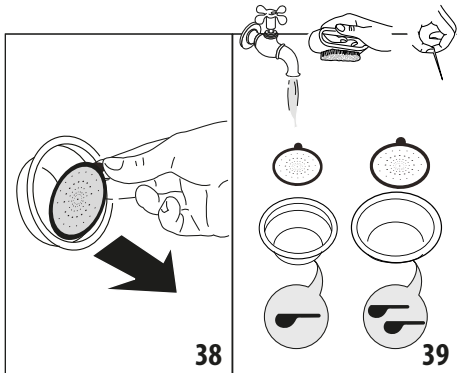

2. Rinse the filters under running water (fig. 39).
3. Make sure the holes are not blocked. If necessary, clean with a pin (fig. 39-40).
4. Dry all the components with a cloth.
5. Put the perforated filter back in the housing and press as far as it will go (fig. 37).

13.5 Cleaning the boiler outlet

After every 200 coffees, rinse the boiler outlet. Press the  rinse button (B4) and deliver about 200 ml of water.

13.6 Cleaning the water tank

1. Remove the filter (*if present) and rinse with running water.
2. Clean the water tank regularly (about once a month) and whenever you replace the water softener filter (C6) (*if present) with a damp cloth and a little mild washing up liquid, then rinse thoroughly.
3. Replace the filter (*if present), fill the tank with fresh water and replace the tank.
4. (Models with water softener filter only) Deliver about 100 ml of water.

Danger!

While cleaning, never immerse the coffee maker in water. It is an electrical appliance.

13.7 Cleaning the beans container

Without extracting it, clean the beans container regularly with a cloth.

For more thorough cleaning, proceed as follows:

1. Make sure the beans container (A2) is empty. If necessary, operate the coffee mill without beans to empty it:
2. Release the beans container by turning it anticlockwise and extract from the appliance.

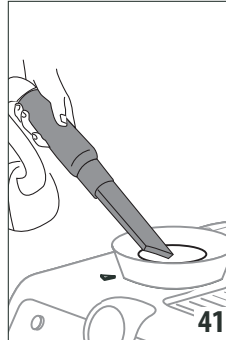

3. Wash the container and lid (A1) with warm water. Do not wash the components in a dishwasher or use washing up liquid! Dry all accessories thoroughly before using again.
4. Remove coffee residues (fig. 41);
5. Clean the beans container housing with a damp cloth and dry;
6. Put the container back as described in section "3. Setting up the appliance".

13.8 Cleaning the burrs

When cleaning the beans container, clean the container housing and upper burr with a damp cloth. The burr can be removed and replaced when worn. Contact an authorised customer services centre. You may also need to remove the burr if it becomes blocked with foreign matter. If this occurs, clean as follows:

1. Empty the beans container (if necessary, using a vacuum cleaner to remove any remaining beans).
2. Attach the filter holder and operate the mill without beans to free the coffee guide, then attach the filter holder to the outlet of the coffee mill (A22), lining it up with "INSERT", then turning it to the right (fig. 18). Grinding begins when the filter holder reaches the CLOSE position and stops automatically;
3. Turn the appliance off;
4. Remove the beans container as described in the previous section "13.7 Cleaning the beans container".
5. Turn the fineness selector anticlockwise as far as it will go to the "REMOVE" position (fig. 42).

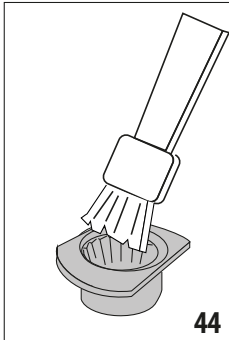
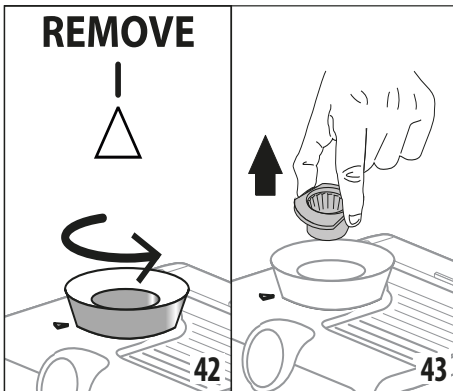

6. Extract the upper burr, gripping it by the handle (fig. 43).
7. Clean the burr with a brush (fig. 44) and remove the coffee residues using a vacuum cleaner (fig. 41).

8. Put the upper burr back in place:

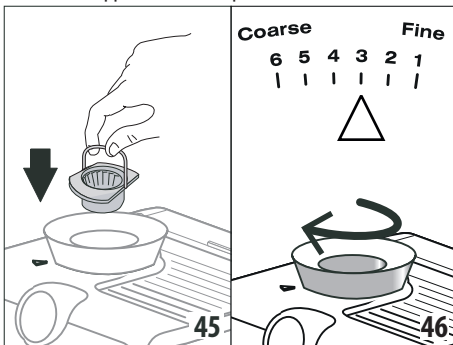

- Insert the burr in its housing (fig. 45);
 - Turn the selector to select the desired grinding level (fig. 46);
 - Make sure the burr is inserted correctly by pulling it by the handle. If it is correctly inserted, it will not move;
9. Use a brush to remove any coffee residues from the outlet of the coffee mill (A22).

13.9 Replacing the burrs

When the quantity of coffee becomes even less, contact a customer services centre to have the burrs replaced, then adjust the mill again as follows:

1. Press and hold the $\times 2$ (B3) and my (B7) buttons for at least 3 seconds to access the menu. The my (B15) and \perp (B16) lights alternate;
2. Turn the mode selection dial (B8) to the my position. The my light (B14) remains on steadily;
3. Select the original grinding range by pressing the $\times 2$ button;
4. Press the \perp button (B1) to exit the menu. (If the appliance is left idle for about 1 minute, it exits automatically from the settings menu and is ready for use again);
5. Turn the ground coffee quantity dial (B2) to the min position, then proceed to adjust as though it were the first time ("4.5 Adjusting the quantity of ground coffee in the filter").

13.10 Cleaning the "Smart tamping station"

To guarantee top quality grinding, clean the "Smart tamping station" regularly as follows:

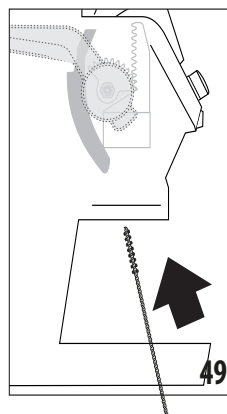
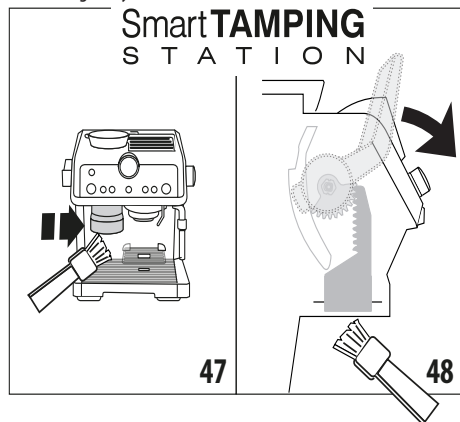

1. Clean the attachment area with a brush (fig. 7).
2. Pull the lever (A23) as far as it will go and clean the presser cylinder with a brush (fig. 48). Then release the lever.
3. Use the tube brush (C8) to clean the coffee guide (fig. 49).

13.11 Other cleaning operations









1. Do not use solvents or abrasive detergents to clean the coffee maker. Use a soft damp cloth only.
2. Clean the filter holder cup.
3. You are recommended to use De'Longhi detergent.

14. DESCALING

Descal the appliance when the  light (B9) comes on.

- Before use, read the instructions and the labelling on the descaler pack.
- It is important to use De'Longhi descaler only. Using unsuitable descaler and/or performing descaling incorrectly may result in faults not covered by the manufacturer's guarantee.

Proceed as follows:

1. (IF PRESENT, REMOVE THE WATER SOFTENER FILTER). Pour the descaler into the tank up to the level  **A** marked inside the tank (equal to one 100ml packet), then add water (litre) up to the level  **B**.
2. If the appliance is off, press the ON/Standby button (B1).
3. Make sure the filter holder is not attached and position a recipient under the spouts (A5), (A6) and the boiler outlet (A21) (fig. 8).
4. Turn the mode selector dial (B8) to the  position. The  light flashes and the  light comes on.
5. Press  (B5) to start descaling.
6. The descale programme starts and the descaler liquid comes out of the spouts and boiler outlet. The descale programme removes limescale deposits from inside the appliance by automatically performing a series of rinses and pauses until the tank is empty.
7. Delivery stops and the  (B15) and  lights corresponding to the rinse button (B4) come on.
8. Empty the recipient used to collect the descaler solution and replace it empty under the spouts.
9. Remove the water tank, empty any residues of descaler solution, rinse with running water and fill with fresh water up to the MAX level. Put the tank back in its housing.
10. Press the  button. The appliance rinses the internal circuits and delivers water from all three spouts.
11. When rinsing is complete, delivery stops. All the LEDs flash briefly and the appliance prepares to be used again.
12. Empty the recipient used to collect the rinse water.
13. Extract and empty the drip tray, then put back in the appliance.
14. Extract the tank, fill with fresh water, then put back in the appliance.
15. Turn the mode selector dial to one of the coffee positions.







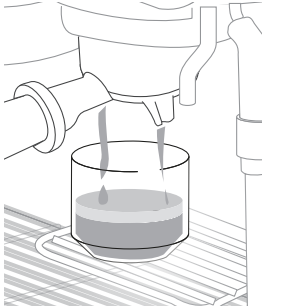
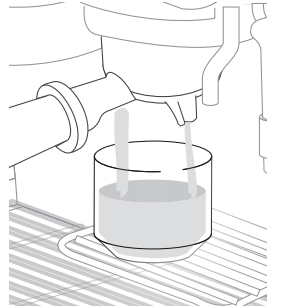
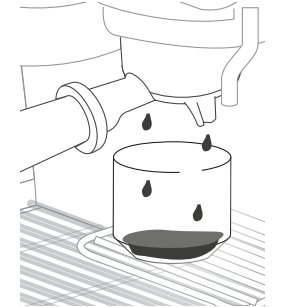
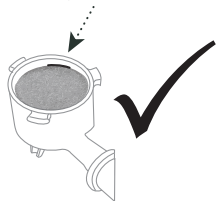

15. TECHNICAL DATA











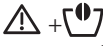

Mains voltage:	220-240V-50-60Hz
Absorbed power:	1450W
Size LxDxH:	375x368x445 mm
MAX. pressure:	19 bars
Water tank capacity:	2 L
Power cable length:	1200 mm
Weight:	12 kg



16. HOW TO MAKE PERFECT COFFEE

PERFECT ESPRESSO	UNDER-EXTRACTED COFFEE	OVER-EXTRACTED COFFEE
		
<p>FROTH: nut-brown coloured with dark lights and light-coloured streaks, 3-4 mm thick</p>	<p>FROTH: clear and thin with large bubbles</p>	<p>FROTH: dark and thin, only at the edges</p>
<p>BODY: dense, full-flavoured and smooth</p>	<p>BODY: thin, watery</p>	<p>BODY: excessive</p>
<p>TASTE: well-balanced and lingering</p>	<p>TASTE: weak and short-lived</p>	<p>TASTE: strong, astringent, lingering and bitter on the palate</p>
<p>AROMA: intense</p>	<p>AROMA: not pronounced</p>	<p>AROMA: weak, with a hint of burnt coffee</p>
<p>GRINDING LEVEL: Correct</p>	<p>GRINDING LEVEL: too coarse. Adjust the mill to a lower position, following the instructions in section "4.5 Adjusting the quantity of ground coffee in the filter"</p>	<p>GRINDING LEVEL: too fine. Adjust the mill to a higher position, following the instructions in section "4.5 Adjusting the quantity of ground coffee in the filter"</p>
<p>COFFEE QUANTITY: Correct</p> 	<p>QUANTITY OF COFFEE IN FILTER: Not enough. Increase the quantity by turning the dial "B2. Ground coffee quantity dial" as described in section "4.5 Adjusting the quantity of ground coffee in the filter"</p>	<p>QUANTITY OF COFFEE IN FILTER: Too much: reduce the quantity by turning the dial "B2. Ground coffee quantity dial" as described in section "4.5 Adjusting the quantity of ground coffee in the filter"</p>



17. EXPLANATION OF LIGHTS

LIGHTS	EXPLANATION OF LIGHTS	OPERATION
All the lights flash briefly	Turning the machine on	Self-diagnosis
 on	Insufficient water in tank or water tank not inserted correctly	Fill the tank or extract the tank and put it back correctly
 on	Energy saving is enabled	See section "12.5 Energy saving" if you want to disable the function
 on	The appliance is on and ready for use	The appliance is at the right temperature to deliver steam. To deliver steam, turn the steam dial (A4)
 flashing	The appliance is on and energy saving is enabled. The steam dial (A4) is in the steam delivery position	The light flashes to indicate that the appliance is preparing to deliver steam. Delivery begins as soon as the appliance is at temperature
	The appliance is heating up to be ready for use	The appliance is at temperature when the light remains on steadily
 on	Presser lever (A23) is not in the correct position	Turn the lever back in place.
 flashing	Pressing is needed	The coffee has just been ground and the filter holder is attached to the coffee mill
	The filter holder has been detached from the coffee mill without pressing	Detach the filter holder and press the coffee as described in section "7. Using pre-ground coffee"
	The filter holder has been detached before grinding has ended or pressing has been performed too quickly	Repeat grinding
	The slide of coffee grinder is clogged	Clean as described in section "13.10 Cleaning the "Smart tamping station"" and section "18. Troubleshooting" in correspondence to fig. 50.
	The burrs are blocked by foreign matter	Remove the foreign matter and clean the burrs as described in section "13.8 Cleaning the burrs".
 on	The beans container is empty	Fill the beans container
 flashing	The beans container is not inserted or is not correctly screwed in place, or the selector on the bottom of the container is not in a position from 1 to 6.	Put the beans container in the appliance correctly
...→		

LIGHTS	EXPLANATION OF LIGHTS	OPERATION
 flash briefly at regular intervals	The dial (B2) has been turned to the maximum adjustment possible 	When not enough coffee is ground to reach the correct quantity, select the new grinding range as described in section "12.6 Extra grinding adjustment".
 flashing	The appliance is too hot to make coffee	Wait for it to cool
 on	Descaling must be performed	Descale the appliance as described in section "14. Descaling"
 flashing	Descaling is underway	Complete the operation as described in section "14. Descaling"
	Descaling has ended and the dial (B8) is in the "descaling" position	Turn the mode selector dial to one of the "coffee positions"
 flashing quickly	The dial (B8) is in the descaling position	Turn the dial to one of the beverage positions
 on	The appliance is being turned on for the first time and the water circuit must be filled	Proceed as described in section "3. Setting up the appliance".
 +  flashing	If the water softener filter (C6) is present, an air bubble may have been released inside the circuit, obstructing delivery	Press the button (B6) corresponding to the  light (fig. 9). Delivery begins and stops automatically.
	The grinding is too fine and the coffee is delivered too slowly or not at all	Extract the filter holder and repeat the operations to make the coffee, bearing in mind the indications in section "4.5 Adjusting the quantity of ground coffee in the filter" and table "16. How to make perfect coffee".
 flashing	The drip tray (A13) is missing or has not been inserted correctly	Extract the drip tray then put back correctly in the appliance
 on	General alarm	Contact Customer Services
...→		

LIGHTS	EXPLANATION OF LIGHTS	OPERATION
 +  flashing	If the water softener filter (C6) is present, an air bubble may have been released inside the circuit, obstructing delivery	Press the button (B6) corresponding to the  light (fig. 9). Delivery begins and stops automatically.
	The grinding is too fine and the coffee is delivered too slowly or not at all	Extract the filter holder and repeat the operations to make the coffee, bearing in mind the indications in section "4.5 Adjusting the quantity of ground coffee in the filter" and table "16. How to make perfect coffee".
	The filter is blocked, or the perforated filter is missing	Clean as described in section "13.4 Coffee filter cleaning and maintenance" and make sure the perforated filter is put back correctly
	The tank has been inserted incorrectly and the valves on the bottom are not open	Press the tank down lightly to open the valves on the bottom
	Scale in the water circuit	Descal as described in section "14. Descaling"

18. TROUBLESHOOTING

PROBLEM	CAUSE	SOLUTION
No espresso coffee is delivered	No water in the tank (A17)	Fill the tank
	The  light is on to indicate that the coffee or steam circuit is empty.	Press the button corresponding to the  light to fill the circuit.
	The filter is blocked, or the perforated filter is missing	Clean as described in section "13.4 Coffee filter cleaning and maintenance" and make sure the perforated filter is put back correctly
	The tank has been inserted incorrectly and the valves on the bottom are not open	Press the tank down lightly to open the valves on the bottom
	Scale in the water circuit	Descal as described in section "14. Descaling"
The filter holder cannot be attached to the appliance	The ground coffee has not been pressed or is too much	Clean as described in section "4.4 Grind the coffee directly into the filter"
The espresso coffee drips from the edges of the filter holder rather than the holes	The filter holder is inserted incorrectly	Attach the filter holder correctly and rotate firmly as far as it will go
	The espresso boiler gasket has lost elasticity or is dirty	Have the espresso boiler gasket replaced by Customer Services
	The filter is clogged, or the perforated filter is missing or dirty	Clean as described in section "13.4 Coffee filter cleaning and maintenance"
...→		

PROBLEM	CAUSE	SOLUTION
The coffee froth is too light (delivered from the spout too fast)	The appliance settings need reviewing	See section "16. How to make perfect coffee"
The coffee froth is too dark (delivered from the spout too slowly)	The appliance settings need reviewing	See section "16. How to make perfect coffee"
No milk froth is formed when making cappuccino	The ring (A7) is in the "FLAT" (NO FROTH) position	Push the ring into the "FOAM" position
	Milk not cold enough	Always use semi-skimmed milk at refrigerator temperature.
	The cappuccino maker (A8) is dirty	Clean the cappuccino maker as described in section "10. Cleaning the cappuccino maker after use"
	Scale in the water circuit	Descale as described in section "14. Descaling"
At the end of descaling, the appliance requests a further rinse	During the rinse cycle, the water tank has not been filled to the MAX level	Repeat the rinse cycle from point (8) of section "14. Descaling"
The appliance does not grind the coffee	There is foreign matter that cannot be ground in the coffee mill	Clean the burrs as described in section "13.8 Cleaning the burrs", making sure you remove all the beans from the beans container (A2) before extracting it. Before putting the burr back, vacuum all residues from the housing (fig. 44).
If you want to change the type of coffee	You must remove all the beans present in the machine	<ul style="list-style-type: none"> • Empty the beans container (if necessary, operate the coffee mill without beans or use a vacuum cleaner to remove any remaining beans). • Attach the filter holder and operate the coffee mill a number of times without beans to free the coffee guide. Attach the filter holder to the outlet of the mill (A22), lining it up with "INSERT", then turning it to the right (fig. 22). Grinding begins when the filter holder reaches the CLOSE position and stops automatically. Repeat until the filter is empty. • Place the new coffee in the beans container. • If the amount of coffee ground is not enough to reach the "perfect quantity", proceed as described in section "4.5 Adjusting the quantity of ground coffee in the filter".
		...→

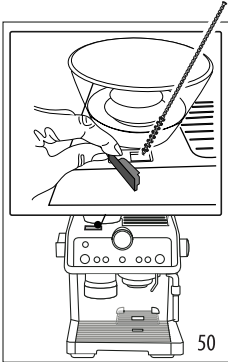
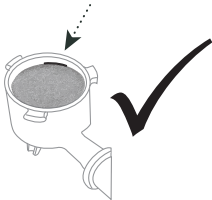
PROBLEM	CAUSE	SOLUTION
<p>After grinding, the coffee filter is empty</p> <p>After grinding, there is too much coffee in the filter</p>	<p>The coffee mill coffee guide is clogged</p>	<p>Clean as described in section "13.10 Cleaning the "Smart tamping station"". If the problem persists, access the guide by opening the hatch and free it using the brush (fig. 50).</p> 
<p>After grinding, the ground coffee in the filter does not reach the "perfect amount of coffee"</p> 	<p>The "Smart Tamping Station" needs cleaning</p> <p>The quantity of ground coffee needs adjusting</p> <p>Over time the burrs wear down</p>	<p>Clean as described in section "13.11 Cleaning the "tamping station", then grind again.</p> <p>Adjust the quantity of coffee with the dial (B2), following the instructions in section "4.5 Adjusting the quantity of ground coffee in the filter". If the dial is already in the max. position, proceed as described in section "12.6 Extra grinding adjustment".</p> <p>Replace the burrs as described in section "13.9 Replacing the burrs".</p>