

## CONTENTS

<b>1. FUNDAMENTAL SAFETY WARNINGS .....</b>	<b>58</b>
<b>2. SAFETY WARNINGS .....</b>	<b>59</b>
2.1 Symbols used in this Instruction for Use .....	59
2.2 Designated use .....	59
2.3 Instruction for Use .....	59
<b>3. INTRODUCTION .....</b>	<b>59</b>
1.1 Letters in brackets .....	59
1.2 Troubleshooting and repairs .....	60
3.1 Download the App! .....	60
<b>4. DESCRIPTION .....</b>	<b>60</b>
1.3 Description of the appliance .....	60
4.1 Description of the control panel .....	60
4.2 Description of the accessories .....	60
4.3 Description of the milk container .....	61
<b>5. BEFORE USE .....</b>	<b>61</b>
5.1 Checking the appliance .....	61
5.2 Installing the appliance .....	61
5.3 Connecting the appliance .....	61
5.4 Setting up the appliance .....	61
<b>6. TURNING THE APPLIANCE ON .....</b>	<b>62</b>
<b>7. TURNING THE APPLIANCE OFF .....</b>	<b>62</b>
<b>8. MENU SETTINGS .....</b>	<b>62</b>
8.1 Rinsing .....	62
8.2 Language .....	62
8.3 Maintenance .....	63
8.4 Program beverages .....	63
8.5 Program My beverages .....	64
8.1 General .....	64
6.1 Bluetooth .....	65
3.1 Statistics .....	65
<b>9. MAKING COFFEE .....</b>	<b>65</b>
4.1 Temporarily varying the coffee aroma .....	65
4.2 Making automatic recipes using coffee beans .....	65
4.1 Making coffee using pre-ground coffee .....	66
5.1 Adjusting the coffee mill .....	67
5.2 Tips for a hotter coffee .....	67
<b>10. MAKING CAPPUCCINOS AND MILK-BASED COFFEES .....</b>	<b>67</b>
5.3 Filling and attaching the milk container .....	67
10.1 Adjusting the amount of froth .....	67
10.2 Making cappuccino and milk-based coffees automatically .....	68
8.1 Cleaning the milk container after use .....	68
<b>11.  PROGRAMMING AND SELECTING ...</b>	<b>68</b>
<b>12. DELIVERING HOT WATER .....</b>	<b>69</b>
<b>13. STEAM DELIVERY .....</b>	<b>69</b>
2.1 Tips for using steam to froth milk .....	69
2.2 Clean the hot water/steam spout after use .....	69
<b>14. CLEANING .....</b>	<b>70</b>
6.1 Cleaning the machine .....	70
6.2 Cleaning the machine's internal circuit .....	70
14.1 Cleaning the coffee grounds container .....	70
6.3 Cleaning the drip tray and condensate tray .....	70
14.2 Cleaning the inside of the coffee machine .....	71
14.3 Cleaning the water tank .....	71
4.1 Cleaning the coffee spouts .....	71
14.4 Cleaning the pre-ground coffee funnel .....	71
14.5 Cleaning the infuser .....	71
14.6 Cleaning the milk container .....	71
14.7 Cleaning the hot water nozzle .....	72
<b>15. DESCAL .....</b>	<b>72</b>
<b>16. SETTING WATER HARDNESS .....</b>	<b>73</b>
10.1 Measuring water hardness .....	73
16.1 Setting water hardness .....	73
<b>17. WATER SOFTENER FILTER .....</b>	<b>73</b>
10.2 Installing the filter .....	73
2.1 Replacing the filter .....	74
2.2 Removing the filter .....	74
<b>18. TECHNICAL DATA .....</b>	<b>74</b>
<b>19. DISPOSING OF THE APPLIANCE .....</b>	<b>75</b>
<b>20. DISPLAYED MESSAGES .....</b>	<b>75</b>
<b>21. TROUBLESHOOTING .....</b>	<b>77</b>

## 1. FUNDAMENTAL SAFETY WARNINGS

---

- The appliance is not intended for use by persons (including children) with reduced physical, sensory or mental capabilities, or lack of experience and knowledge, unless they have been given supervision or instruction concerning use of the appliance by a person responsible for their safety.
- Children should be supervised to ensure that they do not play with the appliance.
- Designated use: this appliance is designed and made to prepare beverages based on coffee, milk and hot water. Any other use is considered improper and thus dangerous. The manufacturer is not liable for damage deriving from improper use of the appliance.
- The surface of the heating element remains hot after use and the outside of the appliance may retain the heat for several minutes depending on use.
- To clean, follow the instructions in the section “13. CLEANING”.
- Cleaning and user maintenance shall not be made by children without supervision.
- Never clean by immersing the appliance in water.
- CAUTION: to prevent damage to the appliance, do not clean with alkaline detergents; use a soft cloth and, where applicable, neutral detergent.
- This is an household appliance only. It is not intended to be used in: staff kitchen areas in shops, offices and other working environments; farm houses; by clients in hotels, motels and other residential type environments; bed and breakfast type environments.
- If the plug or power cord is damaged, it must be replaced by customer services only to avoid all risk.
- Appliances with removable cord: avoid splashes of water on the power cord connector or socket at the back of the appliance.
- IMPORTANT: Models with glass surfaces: do not use the appliance if the surface is cracked.
- Coffee maker shall not be placed in a cabinet when in use.

### **FOR EUROPEAN MARKETS ONLY:**

- This appliance can be used by children aged from 8 years and above if they have been given supervision or instruction concerning use of the appliance in a safe way and understand the hazards involved.  
Cleaning and user maintenance shall not be made by children unless they are above 8 years old and supervised.  
Keep the appliance and power cord away from children under 8 years of age.
- Appliances can be used by persons with reduced physical, sensory or mental capabilities or lack of experience and knowledge if they are supervised or have been given

instruction concerning use of the appliance in a safe way and if they understand the hazards involved.

- Children shall not play with the appliance.
- Always unplug the appliance when left unattended and before assembly, taking apart or cleaning.



Surfaces marked with this symbol become hot during use (the symbol is present in certain models only).

---

## 2. SAFETY WARNINGS

### 2.1 Symbols used in this Instruction for Use

Important warnings are identified by these symbols. It is vital to respect these warnings.



**Danger!**

Failure to observe the warning may result in life threatening injury by electric shock.



**Important!**

Failure to observe the warning could result in injury or damage to the appliance.



**Danger of burns!**

Failure to observe the warning could result in scalds or burns.



**Please note:**

This symbol identifies important advice or information for the user.



**Danger!**

This is an electrical appliance and may cause electric shock.

You should therefore follow these safety warnings:

- Never touch the appliance with damp hands or feet.
- Never touch the plug with damp hands.
- Make sure the socket used is freely accessible at all times, enabling the appliance to be unplugged when necessary.
- Unplug directly from the plug only. Never pull the cord as you could damage it.
- To disconnect the appliance completely you must unplug it from the mains socket.
- If the appliance is faulty, do not attempt to repair. Turn it off, unplug from the mains socket and contact Customer Services.
- Before cleaning the appliance, turn it off, unplug from the mains socket and allow to cool.



**Important:**

Keep all packaging (plastic bags, polystyrene froth) away from children.



**Danger of burns!**

This appliance produces hot water and steam may form while it is in operation.

Avoid contact with splashes of water or hot steam.

When the appliance is in operation, the cup shelf could become very hot.

### 2.2 Designated use

This appliance is designed and made to prepare coffee and milk based beverages and hot water.

Any other use is considered improper and thus dangerous. The manufacturer is not liable for damage deriving from improper use of the appliance.

### 2.3 Instruction for Use

Read this Instruction for Use carefully before using the appliance. Failure to follow this Instruction for Use may result in burns or damage to the appliance.

The manufacturer is not liable for damage deriving from failure to respect this Instruction for Use.



**Please note:**

Keep this Instruction for Use. If the appliance is passed to other persons, they must also be provided with this Instruction for Use.

## 3. INTRODUCTION

Thank you for choosing this bean to cup espresso and cappuccino machine.

We hope you enjoy using your new appliance. Take a few minutes to read this Instruction for Use. This will avoid all risks and damage to the appliance.

### 1.1 Letters in brackets

The letters in brackets refer to the legend in the description of the appliance on pages 2-3.

## 1.2 Troubleshooting and repairs

In the event of problems, first try and resolve them by reading the information given in sections "20. Displayed messages" and "21. Troubleshooting".

If this does not resolve the problem or you require further information, you should consult Customer Services by calling the number given on the annexed "Customer Service" sheet.

If your country is not among those listed on the sheet, call the number given in the guarantee. If repairs are required, contact De'Longhi Customer Services only. The addresses are given in the guarantee certificate provided with the machine.

## 3.1 Download the App!



A number of functions can be controlled remotely using the De'Longhi Coffee Link App.

In the App, you can also find information, tips and curious facts about the world of coffee, together with information on your machine at your fingertips.



This symbol highlights the functions you can control or consult using the App.

You can also create up to 3 new beverages and save them in your appliance.



**Please note:**

Check compatible devices at [compatibledevices.delonghi.com](http://compatibledevices.delonghi.com).

## 4. DESCRIPTION

### 1.3 Description of the appliance

(page 3 - A)





- A1. Beans container lid
- A2. Top lid
- A3. Grinding adjustment dial
- A4. Beans container
- A5. Pre-ground coffee funnel lid
- A6. Pre-ground coffee funnel
- A7. Main switch
- A8. Power cord connector socket
- A9. Infuser
- A10. Infuser door
- A11. Cup warmer
- A12.  button: to turn the appliance on and off (standby)

- A13. Control panel
- A14. Coffee spouts (adjustable height)
- A15. Hot water and steam connection nozzle
- A16. Condensate tray
- A17. Water tank lid
- A18. Water tank
- A19. Water softener filter housing
- A20. Coffee grounds container
- A21. Cup tray
- A22. Drip tray water level indicator
- A23. Drip tray grille
- A24. Drip tray





### 4.1 Description of the control panel

(page 2 - B)





A number of buttons on the control panel have a double function. This is indicated in brackets in the description.

- B1. Display: guides the user in using the appliance.
- B2. : appliance settings menu (*When in the settings menu, it acts as the "ESC" button to exit from the selected function and go back to the main menu*)
- B3. : aroma selection (*When you access the settings MENU, it acts as the "OK" button to confirm the selection made*)
- B4. : Beverage selection menu (other than directly selected beverages): Ristretto, Espresso Lungo, 2 Espresso, Flat white, Espresso Macchiato, Cappuccino+, Cappuccino Mix, Hot water, Steam (*press to scroll up*)
- B5. : My beverages selection menu. Unless previously programmed from the settings menu "8.1 Program My beverages", the beverage is programmed directly the first time you use the appliance (*press to scroll down*)

#### Directly selected milk based beverages:

- B6. : Cappuccino
- B7. : Latte macchiato
- B8. : Hot milk
- B9. : Caffelatte

#### Directly selected coffees:

- B10. : Espresso
- B11. : Doppio+
- B12. : Coffee
- B13. : Long

### 4.2 Description of the accessories

(page 2 - C)

- C1. Indicator paper (attached to the English instructions)
- C2. Pre-ground coffee measure
- C3. Descaler
- C4. Water softener filter (certain models only)
- C5. Cleaning brush
- C6. Hot water spout

- C7. Spout release button
- C8. Power cord

### 4.3 Description of the milk container

(page 2 - D)

- D1. Froth adjustment and CLEAN dial
- D2. Milk container lid
- D3. Milk container
- D4. Milk intake tube
- D5. Frothed milk spout (adjustable)

## 5. BEFORE USE

### 5.1 Checking the appliance

After removing the packaging, make sure the product is complete and undamaged and that all accessories (C) are present. Do not use the appliance if it is visibly damaged. Contact De'Longhi Customer Services.

### 5.2 Installing the appliance



#### **Important!**

When you install the appliance, you should respect the following safety warnings:

- The appliance gives off heat. After positioning the appliance on the worktop, leave a space of at least 3 cm between the surfaces of the appliance and the side and rear walls and at least 15 cm above the coffee maker.
- Water penetrating the appliance could cause damage. Do not place the appliance near taps or sinks.
- The appliance could be damaged if the water it contains freezes. Do not install the appliance in a room where the temperature could drop below freezing point.
- Arrange the power cord (C8) in such a way that it cannot be damaged by sharp edges or contact with hot surfaces (e.g. electric hot plates).

### 5.3 Connecting the appliance



#### **Important!**

Check that the mains power supply voltage corresponds to that indicated on the rating plate on the bottom of the appliance. Connect the appliance to an efficiently earthed and correctly installed socket with a minimum current rating of 10A only. If the power socket does not match the plug on the appliance, have the socket replaced with a suitable type by a qualified electrician.





### 5.4 Setting up the appliance



#### **Please note:**

- Coffee has been used to factory test the appliance and it is therefore completely normal for there to be traces of coffee in the mill. The machine is, however, guaranteed to be new.
- You should customise water hardness as soon as possible following the instructions in section "16. Setting water hardness".

1. Plug the power cord (C8) connector into the socket (A8) at the back of the appliance and connect the appliance to the mains electricity supply (fig. 1). Make sure the main switch (A7) at the back of the appliance is pressed (fig. 2);
2. "Language": press (selection arrows ) (B4) or  (B5) until the required language is displayed between the two dotted lines, then press  (B3) to confirm.

Follow the instructions indicated on the appliance display (B1):

3. "Fill tank": remove the water tank (A18), fill to the MAX line (marked on the inside of the tank) with fresh water (fig. 3A), then reposition the tank (fig. 3B);
4. "Insert water spout": check that the hot water spout (C6) is attached to the nozzle (A15) (fig. 4) and place a container (fig. 5) underneath it with a minimum capacity of 100 ml;
5. "Water circuit empty, Fill water circuit, Hot water, Confirm?";
6. Press  to confirm. The appliance delivers hot water from the spout then goes off automatically.

The coffee machine is now ready for normal use.



#### **Please note:**

- When using for the first time, you need to make 4/5 cappuccinos before the appliance starts to give satisfactory results.
- When using for the first time, the water circuit is empty, and the appliance may be very noisy: the noise will abate gradually as the circuit fills up.
- When making the first 5-6 cappuccinos, it is normal to hear the noise of boiling water. After this, the noise becomes less.
- To enjoy your coffee even more and improve the performance of your appliance, we recommend installing a water softener filter (C4) as described in section "17. Water softener filter". If your model is not supplied with this filter, you can order one from an authorised De'Longhi technical service centre.



## 6. TURNING THE APPLIANCE ON



### Please note:

Before turning the appliance on, make sure the main switch (A7) on the back of the appliance is pressed (fig. 2).

Each time the appliance is turned on, it performs an automatic preheat and rinse cycle which cannot be interrupted. The appliance is ready for use only after completion of this cycle.



### Danger of burns!

During rinsing, a little hot water comes out of the coffee spouts (A14) and is collected in the drip tray (A24) underneath. Avoid contact with splashes of water.

- To turn the appliance on, press the button (A12) (fig. 6). The message "Heating, Please wait" appears on the display (B1).
- After heating, the message "Rinsing" is displayed, together with a progress bar which gradually fills as preparation proceeds. As well as heating the boiler, the appliance also heats the internal circuits by circulating hot water.

The appliance is at temperature when the message "Select your beverage" is displayed.

## 7. TURNING THE APPLIANCE OFF

Whenever the coffee machine is turned off after being used to make coffee, it performs an automatic rinse cycle.



### Danger of burns!

During rinsing, a little hot water flows from the coffee spouts (A14). Avoid contact with splashes of water.

- To turn the appliance off, press the button (A12-fig. 6);
- The message "Turning off underway Please wait" appears on the display (B1), then (if provided for) the appliance performs a rinse cycle and goes off (standby).



### Please note!

If the appliance is not used for an extended period, first complete the "emptying" procedure (see section "8.3 Maintenance" - "Emptying the circuit:") and then disconnect the appliance from the mains power supply, as follows:

- first turn the appliance off by pressing the button (fig. 6);
- release the main switch (A7) (fig. 2).



### Important!

Never press the main switch while the appliance is on.



## 8. MENU SETTINGS

The menu has 8 items, some divided into subgroups:

- Rinsing;
- Maintenance:
- Language;
- Descale,

- Install filter,
- (if a filter has been installed): Replace filter,
- (if a filter has been installed): Remove filter;
- Emptying the circuit;
- Prg. beverages;
- Prg. My beverages;
- General:
- Set temperature,
- Water hardness,
- Auto-off,
- Energy saving,
- Beep,
- Cup warmer,
- Cup lighting
- Default beverages,
- Default values;
- Bluetooth
- Statistics.

### 8.1 Rinsing

Use this function to deliver hot water from the coffee spouts (A14) and hot water/steam spout (C6), if inserted, to clean and heat the appliance's internal circuit.

Place a container with a minimum capacity of 100ml under the coffee and hot water spouts.

To enable the function, proceed as follows:

- Press (B2) to enter the menu;
- Press the selection arrows (B4) or (B5) until "Language" is displayed between the two dotted lines;
- Press (B3) to start rinsing.



### Important! Danger of burns.

Do not leave the appliance unattended while hot water is being delivered.

- After a few seconds, hot water is delivered first from the coffee spouts, then from the hot water/steam spout (if inserted) to clean and heat the appliance's internal circuit. "Rinsing" appears on the display, together with a progress bar which fills gradually as preparation proceeds;
- To stop rinsing press (B5) or (B2) or wait until it finishes automatically.



### Please note!

- If the appliance is not used for more than 3-4 days, when switched on again, we strongly recommend performing 2/3 rinses before use;
- After cleaning, it is normal for the grounds container (A20) to contain water.

### 8.2 Language

To modify the language of the display (B1), proceed as follows:

- Press (B2) to enter the "Settings" menu;
- press the selection arrows (B4) or (B5) until "Language" is displayed between the two dotted lines;
- Press (B3). The available languages are displayed;
- press the selection arrows or until the required language is displayed between the two dotted lines;
- Press to confirm;













6. The appliance goes back to the “Settings” menu;
7. Then press  to exit the menu.

### 8.3 Maintenance

Here you can find all the maintenance operations required by the appliance over time:

- **Descaling:** For instructions on descaling, see section “15. Descalce”.
- **Install filter/Replace filter/Remove filter:** For instructions on how to install, replace or remove the filter (C4), see section “17. Water softener filter”.
- **Emptying the circuit:**





To select the operation, proceed as follows:

1. Press  (B2) to enter the “Settings” menu;
2. Press the selection arrows  (B4) or  (B5) until “Maintenance” is displayed between the two dotted lines;
3. Press  (B3) to confirm;
4. Press the selection arrows  or  until “Water circuit emptying” is displayed between the two dotted lines;
5. Press ;
6. “Confirm?”: Press  to confirm or  to go back to the previous screen;
7. “Empty grounds container”: extract and empty the grounds container (A20). Press ;
8. “Empty drip tray”: empty the drip tray (A24) and put back in the appliance complete with grounds container and grille (A23). Press ;
9. “Place 0.5l container under spouts”: position a container under the coffee spouts (A14) and hot water spout (C6). Press .



#### **Important! Danger of burns**

Do not leave the appliance unattended while the circuit is emptying.

10. “Rinsing, Please wait”: the appliance performs a rinse cycle from the coffee spouts;
11. “Empty water tank”: remove the tank (A18), empty it completely, then press .
12. (If the filter is installed) “Remove filter”: remove the filter from the tank, then press .
13. “Insert tank, Press OK”: put the tank back in then press .
14. “Water circ. emptying underway”: wait for the appliance to empty the circuit; (Important: hot water from the spouts!); As the circuit empties, the appliance may make more noise: this is completely normal.
15. “Empty drip tray”: remove, empty and reposition the drip tray, then press .
16. “Emptying complete press ok to turn off”: press . The appliance goes off.



























#### **Please note!**

The next time you turn the appliance on, the circuit will need to be filled: follow the instructions in point 3 of section “5.1 Setting up the appliance”.

### 8.4 Program beverages

The appliance is set by default to automatically deliver standard quantities. To modify this quantity and customise the directly selected beverages and the “DRINK MENU”  (B4), proceed as follows:

1. Prepare the appliance for preparation of the beverage as described in section “4.2 Making automatic recipes using coffee beans” or sections “5.3 Filling and attaching the milk container” and “8.1 Adjusting the amount of froth”;
  2. Press  (B2) to enter the “Settings” menu;
  3. Press the selection arrows  (B4) or  (B5) until “Prg. beverages” is displayed between the two dotted lines;
  4. Press  (B3) to confirm: the appliance will list the beverages that can be customised;
  5. Press the selection arrows  or  until the desired beverage is displayed between the two dotted lines: press  to confirm;
  6. **Beverages with coffee:** the display shows “Program aroma”: press the selection arrows  or  until selecting the desired aroma (see section “4.1 Temporarily varying the coffee aroma”), press  to confirm the selection. Beverage preparation then commences and the display shows “Program coffee” with a progress bar that indicates the quantity delivered: once the desired quantity has been delivered, press  or . **Cappuccino and milk-based coffees:** after having selected and confirmed the aroma, beverage preparation commences and the display shows “Program milk” with a progress bar that indicates the quantity of milk delivered: once the desired quantity has been delivered, press  or . The appliance then prepares the coffee: press  or  to stop delivery when the desired quantity of coffee has been delivered. **Hot water:** press . Delivery commences: once the desired quantity has been delivered, press  or .
  7. “Save parameters?”: to save the settings, press  or  (otherwise press  or .
  8. “Parameters saved” (or “Parameters not saved”). The appliance is ready for use again.
- Press  or  to terminate the preparation at any time.



### Please note!

The display shows “OK ▲” - (B5) when the length reaches the minimum programmable quantity.

## 8.5 Program My beverages

Follow the procedures described in the previous section “16.1 Program beverages” customise the beverages in the (B5) by selecting “Prg. My beverages” from the settings menu, or proceed with direct programming, as described in section “11.” “Programming and selecting”.

### 8.1 General

Here you can find the settings to customise the basic functions of the appliance:

1. Press (B2) to enter the “Settings” menu;
2. Press the selection arrows (B4) or (B5) until “General” is displayed between the two dotted lines: press (B3) to confirm;
3. Press the selection arrows (B4) or (B5) until the required item is displayed between the two dotted lines, then follow the specific instructions for each setting:

#### • Set temperature:

To modify the temperature of the water used to make the coffee, proceed as follows:

4. Press . The current value appears on the display (B1) and the “New” value flashes;
5. Select the new value you want to set using the selection arrows (B4) or (B5);
6. When the required value (low, medium, high, maximum) has been selected, press .

The display goes back to the previous screen.

#### • Water hardness:

For instructions on identifying and setting water hardness, see section “16. Setting water hardness”.

#### • Auto-off (standby):

Auto-off can be set so that the appliance goes off after 15 or 30 minutes, or 1, 2 or 3 hours

4. Press . The current value appears on the display (B1) and the “New” value flashes;
5. Select the new value you want to set using the selection arrows (B4) or (B5);
6. When the required value (15 min, 30 min, 1 hour, 2 or 3 hours) has been selected, press .

The display goes back to the previous screen.

#### • Energy saving:

To disable or enable “Energy Saving”, proceed as follows:

4. Press . The display (B1) shows the current status (“Enabled” or “Disabled”), and the operation to be performed when confirming with (“Disable?” or “Enable?”);
5. Press to disable or enable the function.  
The display goes back to the previous screen.



### Please note!

- when the function is enabled, the “ECO” symbol appears on the display.
- When in energy saving mode, a few seconds elapse before the first coffee, cappuccino or milk-based coffee is delivered as the appliance must heat up again.
- If the milk container (D) is inserted, “Energy Saving” cannot be activated.

#### • Beep:

Use this function to enable or disable the beep. Proceed as follows:

4. Press . The display (B1) shows the current status (“Enabled” or “Disabled”), and the operation to be performed when confirming with (“Disable?” or “Enable?”);
5. Press to disable or enable the function.  
The display goes back to the previous screen.

#### • Cup warmer

To warm the cups before making coffee, you can enable the cup warmer (A11) and rest the cups on the shelf.

4. Press . The display (B1) shows the current status (“Enabled” or “Disabled”), and the operation to be performed when confirming with (“Disable?” or “Enable?”);
5. Press to disable or enable the function.  
The display goes back to the previous screen.

#### • Cup lighting

This function enables or disables the cup lighting. The lights come on each time a coffee or milk-based beverage is made and during each rinsing cycle.

To disable or enable this function, proceed as follows:

4. Press . The display (B1) shows the current status (“Enabled” or “Disabled”), and the operation to be performed when confirming with (“Disable?” or “Enable?”);
5. Press to disable or enable the function.

#### • Default beverages

Use this function to reset the default values for all the beverages, or the individual beverages programmed previously.

4. Press (B3). The display (B1) shows the beverages that have been customised and the item “All”;



- Select "All" to reset the aroma and quantity settings to the default values, or select the required beverage, then press (B3) or (B5);
- "Reset?": to reset the default values, press (B3) or (B5);
- "Reset complete": the appliance confirms the reset and goes back to the previous screen.

To reset another beverage, repeat from point 4 or to exit, press (B2).

#### • **Default values:**

Use this function to reset all the appliance and beverage settings (apart from the language which remains as selected the first time the appliance was used).

- Press (B3);
- The display shows "Reset?": press (B3) or (B5) to reset all the settings;
- "Reset complete": the appliance confirms the reset and goes back to the previous screen.

To exit, press (B2).

### 6.1 Bluetooth

In this menu, you can find the serial number to identify the coffee machine from your mobile and enable PIN protection of the appliance.

- Press (B2) to enter the "Settings" menu;
- Press the selection arrows (B4) or (B5) until "Bluetooth" is displayed between the two dotted lines;
- Press (B3) to confirm and select the required item using the selection arrows (B4) or (B5).

#### • **Serial number:**

- Press (B3). The serial number appears on the display (B1). This number unambiguously identifies the appliance you want to connect to via Bluetooth from the App;
- Press (B2) to return to the previous screen.

#### • **PIN protection:**

- Press (B3). The display (B1) shows the set PIN and "Enabled, Disable?" (or "Disabled, Enable?");
- Press (B3) to confirm the operation. The display goes back to the previous screen.

### 3.1 Statistics

This displays statistics relating to the machine. To display the statistics, proceed as follows:

- Press (B2) to enter the "Settings" menu;
- Press the selection arrows (B4) or (B5) until "Statistics" is displayed between the two dotted lines;

- Press (B3): the display (B1) shows the statistics on the appliance: use the selection arrows to scroll through the items (B4) or (B5);
  - Then press (B2) to exit.
- To return to the main screen, press (B2) again.



## 9. MAKING COFFEE

### 4.1 Temporarily varying the coffee aroma

To temporarily vary the aroma of the coffee in the automatic recipes, press (B3):

	Custom (if programmed) / Standard
	X-LIGHT
	LIGHT
	MEDIUM
	STRONG
	X-STRONG
	(see "4.1 Making coffee using pre-ground coffee")



#### **Please note:**

- The variation in aroma is not saved and the next time a beverage is delivered automatically, the appliance selects the default value ( AUTO).
- If a few seconds elapse between temporary customising of the aroma and delivery of the beverage, the aroma returns to the default value ( AUTO).













### 4.2 Making automatic recipes using coffee beans



#### **Important!**





Do not use green, caramelised or candied coffee beans as they could stick to the coffee mill and make it unusable.

- Fill the container (A4) (fig. 8) with coffee beans;
- Place under the coffee spouts (A14):
  - 1 cup, if you want to make 1 coffee (fig. 9);
  - 2 cups, if you want to make 2 coffees (see note at end of section).
- Lower the spouts as near as possible to the cup. This makes a creamier coffee (fig. 10);
- Then select your required coffee:

Directly selected beverages			
Recipe	Quantity	Program- mable quantity	Default aroma
 Espresso (B10)	≈ 40 ml	from ≈30 to ≈ 80ml	
 Coffee (B12)	≈ 180 ml	f r o m ≈100 to ≈240ml	
 DOPPIO+ (B11)	≈ 120 ml	from ≈80 to ≈180ml	
 Long (B13)	≈ 160 ml	f r o m ≈115 to ≈250ml	
Beverages with coffee selectable from  (B4)			
Espresso Lungo	≈ 120 ml	from ≈80 to ≈180ml	
Ristretto	≈ 30 ml	from ≈20 to ≈40ml	
2 Espresso	≈ 40 ml x 2 cups	--	

- Preparation begins. The beverage selected appears on the display (B1) together with a progress bar which gradually fills as preparation proceeds.

**i Please note:**

- You can prepare 2 cups of RISTRETTO, ESPRESSO or ESPRESSO LUNGO coffee at the same time by pressing "X2"  (B4) during preparation of single beverages (the message is displayed for a few seconds at the start of preparation).
- While the machine is making coffee, delivery can be interrupted at any moment by pressing  (B5) or  (B2).
- At the end of delivery, to increase the quantity of coffee in the cup, just press and hold (within 3 seconds) the "▲ EXTRA" -  button (B4). Once the desired quantity has been delivered, stop by pressing  (B5).

Once the coffee has been made, the appliance is ready to make the next beverage.

**i Please note:**

- Various alarm messages could be displayed while using the appliance (Fill tank, Empty grounds container, etc.). Their meaning is explained in section "21. Troubleshooting".
- For hotter coffee, see section "5.2 Tips for a hotter coffee".
- If the coffee is delivered a drop at a time, too weak and not creamy enough or too cold, read the tips in section "21. Troubleshooting".
- To customise the beverages according to personal taste, see sections "16.1 Program beverages" and "8.1 Program My beverages".



#### 4.1 Making coffee using pre-ground coffee





**! Important!**

- Never add pre-ground coffee when the machine is off or it could spread through the inside of the machine and dirty it. This could damage the appliance.
- Never use more than 1 level measure (C2) or it could dirty the inside of the coffee machine or block the funnel (A6).

**i Please note:**



**If you use pre-ground coffee, you can only make one cup of coffee at a time.**

- Press  (B3) repeatedly until the display (B1) shows" .
- Make sure the funnel is not blocked, then add one level measure of pre-ground coffee (fig. 11).
- Place a cup under the coffee spouts (A14) (fig. 9).
- Then select your required coffee:



Directly selected beverages	
Recipe	Quantity
 Espresso (B10)	≈ 40 ml
 Coffee (B12)	≈ 180 ml
 Long (B13)	≈ 160 ml
Beverages with coffee selectable from  (B4)	
Espresso Lungo	≈ 120 ml
Ristretto	≈ 30 ml

- Preparation begins. The beverage selected appears on the display together with a progress bar which gradually fills as preparation proceeds.

**i Please note:**

At the end of delivery, to increase the quantity of coffee in the cup, just press and hold (within 3 seconds) the "▲ EXTRA" -  button (B4). Once the desired quantity has been delivered, stop by pressing  (B5).

**! Important! Making  LONG coffee:**

Halfway through preparation, the message "Add pre-ground coffee" appears on the display. Add one level measure of pre-ground coffee and press  (B3) or  (B5).

**i Please note:**

- If "Energy Saving" mode is active, you may have to wait a few seconds before the first coffee is delivered.
- Various alarm messages could be displayed while using the appliance (Fill tank, Empty grounds container, etc.). Their meaning is explained in section "21. Troubleshooting".
- For hotter coffee, see section "5.2 Tips for a hotter coffee".
- If the coffee is delivered a drop at a time, too weak and not creamy enough or too cold, read the tips in section "21. Troubleshooting".

### 5.1 Adjusting the coffee mill

The coffee mill is set by default to prepare coffee correctly and should not require regulating initially. However, if after making the first few coffees you find that the coffee is either too weak and not creamy enough or delivery is too slow (a drop at a time), this can be corrected by adjusting the grinding adjustment dial (A3) (fig. 7).

**i Please note:**

The grinding adjustment dial must only be turned when the coffee mill is in operation, in the initial stage of beverage preparation.



If the coffee is delivered too slowly or not at all, turn one click clockwise towards 7. For fuller bodied creamier coffee, turn one click anticlockwise towards 1 (do not turn more than one click at a time otherwise the coffee could be delivered a drop

at a time).

These adjustments will only be evident after at least 2 cups of coffee have been delivered. If this adjustment does not obtain the desired result, turn the dial another click.

### 5.2 Tips for a hotter coffee

For hotter coffee, you should:

- perform a rinse cycle by selecting the "Rinsing" function in the settings menu (section "8.1 Rinsing");

- warm the cups with hot water using the hot water function (see section "12. Delivering hot water");
- increase the coffee temperature in the "Settings" menu (see section "8.2 General").

## 10. MAKING CAPPUCCINOS AND MILK-BASED COFFEES

**i Please note:**

- To avoid milk with poor froth or large bubbles, always clean the milk container lid (D2) and hot water connection nozzle (A15) as described in sections "8.2 Cleaning the milk container after use", "4.3 Cleaning the milk container" and "9.1 Cleaning the hot water nozzle".

### 5.3 Filling and attaching the milk container

1. Remove the lid (D2) (fig. 12);
2. Fill the milk container (D3) with a sufficient quantity of milk, not exceeding the MAX level marked on the handle (fig. 13). Each mark on the side of the container corresponds to 100 ml of milk;
3. Make sure the milk intake tube (D4) is correctly inserted in the bottom of the milk container lid (fig. 14);
4. Place the lid back on the milk container;
5. If present, extract the hot water/steam spout (C6) by pressing the release button (C7) (fig. 15);
6. Attach the container to the connection nozzle and push as far as it will go (fig. 16). The machine emits a beep (if enabled);
7. Place a sufficiently large cup under the coffee spouts (A14) and frothed milk spout (D5). Adjust the length of the milk spout. To move it nearer the cup, simply pull it downwards (fig. 17);
8. Follow the instructions below for each function.



**i Please note:**

- For a denser more even froth, you must use skimmed or partially skimmed milk at refrigerator temperature (about 5°C).
- If "Energy Saving" mode is enabled, you may have to wait a few seconds before the beverage is delivered.

### 10.1 Adjusting the amount of froth

Turn the froth adjustment dial (D1) to adjust the amount of froth on the milk delivered while making cappuccinos and milk-based coffees.





Dial position	Description	Recommended for...
	No froth	HOT MILK (not frothed) / CAFFELATTE

	Min. froth	LATTE MACCHIATO / FLAT WHITE
	Max. froth	CAPPUCCINO / CAPPUCCINO+ / CAPPUCCINO MIX / ESPRESSO MACCHIATO / HOT MILK (frothed)

## 10.2 Making cappuccino and milk-based coffees automatically

- Fill the milk container (D) and attach it as described above;
- Select the required beverage:



### Directly selected beverages:

-  : Cappuccino (B6)
-  : Latte Macchiato (B7)
-  : Hot milk (B8)
-  : Caffelatte (B9)

**Selectable by pressing**  (B4) and confirm by pressing  (B3):

- Flat white
  - Cappuccino+
  - Cappuccino Mix;
  - Espresso macchiato
- After a few seconds, preparation begins automatically and the selected beverage appears on the display, together with a progress bar which gradually fills as preparation progresses;
  - After delivering the milk, the machine automatically makes the coffee (if required by the recipe).

### Please note:

-  (B2): press to completely terminate the preparation and return to the main screen.
- “STOP”  (B5) : press to stop the delivery of milk or coffee and go to the next stage (if featured) to complete the beverage.
- At the end of delivery, to increase the quantity of coffee in the cup, press “▲ EXTRA”-  (B4).
- Do not leave the milk container out of the refrigerator for long periods. The warmer the milk (5°C is ideal), the poorer the quality of froth produced.
- The beverages can be customised (see sections “16.1 Program beverages” and “8.1 Program My beverages”).

## 8.1 Cleaning the milk container after use



### Important! Danger of burns

- When cleaning the internal tubes of the milk container (D), a little hot water and steam leak out of the milk spout (D5). Avoid contact with splashes of water.

“Set dial to CLEAN, ESC to cancel” flashes on the display (B1) each time you use a milk function. Clean as described to eliminate all milk residues (or press  (B2) to clean later):

- Leave the milk container (D) in the machine (you do not need to empty it);
- Place a cup or other recipient under the frothed milk spout (fig. 19);
- Turn the froth adjustment dial (D1) to “CLEAN” (fig. 18). “Cleaning underway” appears on the display, together with a progress bar which gradually fills as the operation proceeds. Cleaning stops automatically;
- Turn the dial back to one of the froth selections;
- Remove the milk container and always clean the steam connection nozzle (A15) with a sponge (fig. 20).









### Please note!

- To prepare a number of cappuccinos or milk-based coffees, clean the milk container after you have prepared the last beverage only. In this case press  when requested, to go back to the main menu.
- If you do not clean the milk container, the  symbol appears on the display to remind you that it needs cleaning.
- The milk container can be kept in the refrigerator.
- In some cases, before cleaning you must wait for the appliance to heat up.

## 11. PROGRAMMING AND SELECTING

In the  you can select beverages customised to your personal tastes. If the beverages have not yet been programmed, the appliance will request the customisation procedure before proceeding with delivery:

### Unprogrammed beverages:

- Press  (B5);
- Press the selection arrows  (B4) or  (B5) until the desired beverage is displayed between the two dotted lines;
- Press  (B3) to select the beverage;
- Beverages with coffee:** the display (B1) shows “Program aroma”: press the selection arrows  or  until selecting the desired aroma. Press  to confirm the selection: beverage preparation then commences and the display shows “Program coffee” with a progress bar that indicates the quantity delivered: once the desired quantity has been delivered, press  or .
  - Cappuccino and milk-based coffees:** after having selected and confirmed the aroma, beverage preparation commences and the display shows “Program milk” with a progress bar that indicates the quantity of milk deliv-

ered: once the desired quantity has been delivered, press



The appliance then prepares the coffee: press or to stop delivery when the desired quantity of coffee has been delivered.

5. “Save parameters?”: to save the settings, press or (otherwise, press or (B3)).
6. “Parameters saved” or “Parameters not saved”. The appliance is ready for use again.



### **Please note!**

The display shows “OK ▲” - (B5) when the length reaches the minimum programmable quantity.

### **Programmed beverages:**

1. Press (B5);
2. Press the selection arrows (B4) or (B5) until the desired beverage is displayed between the two dotted lines;
3. Press (B3) to select;
4. Preparation begins according to the previously programmed settings.



### **Please note:**

- “2 My Espresso” can only be selected when “My Espresso” has already been programmed.
- “STOP” (B5) : press to stop the delivery of milk or coffee and go to the next stage (if featured) to complete the beverage.
- At the end of delivery, to increase the quantity of coffee in the cup, press “▲ EXTRA” - (B4).



## **12. DELIVERING HOT WATER**



### **Important! Danger of burns.**

Never leave the machine unattended while delivering hot water.

1. Make sure the hot water/steam spout (C6) is attached correctly to the hot water/steam connection nozzle (A15);
2. Place a container under the water spout (as close as possible to avoid splashes) (fig. 5);
3. Press (B4) and scroll the beverages in the menu with the selection arrows (B4) or (B5) until “Hot water” is displayed between the two dotted lines;
4. Press (B3): the display shows a progress bar that indicates the quantity delivered;
5. The appliance delivers hot water and then delivery stops automatically. To manually stop the delivery of hot water, press or (B3).



### **Please note:**

- If “Energy Saving” mode is active, you may have to wait a few seconds before the hot water is delivered.

- The quantity of water delivered can be customised (see section “16.1 Program beverages”).



## **13. STEAM DELIVERY**



### **Important! Danger of burns.**

Do not leave the appliance unattended while steam is being delivered.

1. Make sure the hot water/steam spout (C6) is attached correctly to the hot water/steam connection nozzle (A15);
2. Fill a container with the liquid to be heated or frothed and immerse the hot water/steam spout in the liquid;
3. Press (B4) and scroll the beverages in the menu by pressing the selection arrows or (B5) until “Steam” is displayed between the two dotted lines;
4. Press (B3): the display shows a progress bar that indicates the quantity delivered;
5. Once having reached the desired temperature or froth level, to stop the delivery of steam press or (B3).



### **Important!**

Always stop steam delivery before extracting the container containing the liquid to avoid burns from splashes.



### **Please note!**

If “Energy saving” is active, you may have to wait a few seconds before steam is delivered.

### **2.1 Tips for using steam to froth milk**

- When choosing the size of the container, bear in mind that the liquid doubles or triples in volume.
- For a richer denser froth, use skimmed or partially skimmed milk at refrigerator temperature (about 5°C).
- For a creamier froth, rotate the container with slow movements in an upward direction.
- To avoid milk with poor froth or large bubbles, always clean the spout (C6) as described in the following section.

### **2.2 Clean the hot water/steam spout after use**

Always clean the hot water/steam spout (C6) after use to avoid the build-up of milk residues and prevent it from clogging.

1. Place a container under the hot water/steam spout and deliver a little water (see section “12. Delivering hot water”). Then stop the delivery of hot water by pressing (B5) or (B3).
2. Wait a few minutes for the hot water/steam spout to cool down, then extract (fig. 15) by pressing the release button (C7). Hold the spout with one hand and with the other, turn the cappuccino maker and pull it downwards (fig. 21).

3. Also remove the steam connection nozzle by pulling it downwards (fig. 22).
4. Check the hole in the connection nozzle is not blocked. If necessary, clean using a toothpick.
5. Wash all parts of the spout thoroughly with a sponge and warm water.
6. Insert the connection nozzle, then the cappuccino maker on the nozzle by pushing it upwards and turning it clockwise until it is attached.

## 14. CLEANING

### 6.1 Cleaning the machine

The following parts of the machine must be cleaned regularly:

- the appliance's internal circuit;
- coffee grounds container (A20);
- drip tray (A24), condensate tray (A16) and grille (A23);
- water tank (A18);
- coffee spouts (A14);
- pre-ground coffee funnel (A6);
- infuser (A9), accessible after opening the infuser door (A10);
- milk container (D);
- hot water/steam connection nozzle (A15);
- hot water/steam spout (C6 - see section "2.2 Clean the hot water/steam spout after use")



#### **Important!**

- Do not use solvents, abrasive detergents or alcohol to clean the coffee machine. With De'Longhi superautomatic coffee machines, you need not use chemical products to clean the machine.
- None of the components of the appliance can be washed in a dishwasher with the exception of the drip tray grille (A23) and milk container (D).
- Do not use metal objects to remove encrustations or coffee deposits as they could scratch metal or plastic surfaces.

### 6.2 Cleaning the machine's internal circuit

If the appliance is not used for more than 3/4 days, before using it again, we strongly recommend switching it on and:

- performing 2/3 rinse cycles (see section "8.1 Rinsing");
- delivering hot water for a few seconds (section "12. Delivering hot water").



#### **Please note:**

After cleaning, it is normal for the grounds container (A20) to contain water.

### 14.1 Cleaning the coffee grounds container

When "Empty grounds container" appears on the display (B1), the grounds container must be emptied and cleaned. The appliance cannot be used to make coffee until you have cleaned the grounds container (A20). Even if not full, the empty grounds container message appears on the display 72 hours after the first coffee has been prepared. For the 72 hours to be calculated correctly, the machine must never be turned off with the main switch (A7).



#### **Important! Danger of burns**

If you make a number of cappuccinos one after the other, the metal cup tray (A21) becomes hot. Wait for it to cool down before touching it and handle it from the front only.

To clean (with the machine on):

- Remove the drip tray (A24) (fig. 23), empty and clean.
- Empty the grounds container (A20) and clean thoroughly to remove all residues left on the bottom. This can be done with the spatula on the brush (C5) provided.
- Check the condensate tray (A16) (red) and empty if necessary.



#### **Important!**

When removing the drip tray, the grounds container must be emptied, even if it contains few grounds.

If this is not done, when you make the next coffees, the grounds container may fill up more than expected and clog the machine.

### 6.3 Cleaning the drip tray and condensate tray



#### **Important!**

The drip tray (A24) is fitted with a level indicator (A22) (red) showing the level of water it contains (fig. 24). Before the indicator protrudes from the cup tray (A21), the drip tray must be emptied and cleaned, otherwise the water may overflow the edge and damage the appliance, the surface it rests on or the surrounding area.

To remove the drip tray:

1. Remove the drip tray and the coffee grounds container (A20) (fig. 23);
2. Remove the cup tray (A21) and drip tray grille (A23), then empty the drip tray and grounds container and wash all components;
3. Check the red condensate tray (A16) and empty if necessary;
4. Replace the drip tray complete with grille and grounds container.

## 14.2 Cleaning the inside of the coffee machine



### **Danger of electric shock!**

Before cleaning internal parts, the machine must be turned off (see section "7. Turning the appliance off") and unplugged from the mains power supply. Never immerse the coffee machine in water.

1. Check regularly (about once a month) that the inside of the appliance (accessible after removing the drip tray, A24) is not dirty. If necessary, remove coffee deposits with the brush (C5) supplied and a sponge;
2. Remove all the residues with a vacuum cleaner (fig. 25).

## 14.3 Cleaning the water tank

1. Clean the water tank (A18) regularly (about once a month) and whenever you replace the water softener filter (C4) (if provided) with a damp cloth and a little mild washing up liquid;
2. Remove the filter (C4) (if present) and rinse with running water;
3. Replace the filter (if provided), fill the tank with fresh water and replace the tank;
4. (Models with water softener filter only) Deliver 100ml of water to reactivate the filter.

## 4.1 Cleaning the coffee spouts

1. Clean the coffee spouts (A14) regularly with a sponge or cloth (fig. 26A);
2. Check that the holes in the coffee spouts are not blocked. If necessary, remove coffee deposits with a toothpick (fig. 26B).

## 14.4 Cleaning the pre-ground coffee funnel

Check regularly (about once a month) that the pre-ground coffee funnel (A6) is not blocked. If necessary, remove coffee deposits with the brush (C5) supplied.



## 14.5 Cleaning the infuser

The infuser (A9) must be cleaned at least once a month.



### **Important!**

The infuser may not be extracted when the machine is on.

1. Make sure the machine is correctly turned off (see "7. Turning the appliance off");
2. Remove the water tank (A18);
3. Open the infuser door (A10) (fig. 27) on the right side of the appliance;
4. Press the two coloured release buttons inwards and at the same time pull the infuser outwards (fig. 28);

5. Soak the infuser in water for about 5 minutes, then rinse under the tap;



### **Important!**

Rinse with water only

No washing up liquid - no dish washer

Clean the infuser without using washing up liquid as it could be damaged.

6. Use the brush (C5) to remove any coffee residues left in the infuser housing, visible through the infuser door;
7. After cleaning, replace the infuser by sliding it onto the internal support, then push the PUSH symbol fully in until it clicks into place;



### **Please note:**

If the infuser is difficult to insert, before insertion, adapt it to the right size by pressing the two levers (fig. 29).

8. Once inserted, make sure the two coloured buttons have snapped out;
9. Close the infuser door;
10. Put the water tank back.

## 14.6 Cleaning the milk container

Clean the milk container (D) each time you prepare milk as described below:

1. Remove the lid (D2);
2. Remove the milk spout (D5) and intake tube (D4) (fig. 30);
3. Turn the froth adjustment dial (D1) anticlockwise to the "INSERT" position (fig. 31) and pull off upwards;
4. Wash all the components thoroughly with hot water and mild washing-up liquid. **All components are dishwasher safe, placing them in the top basket of the dishwasher.**
5. Make sure there are no milk residues on the hollow and groove under the dial (fig. 32). If necessary, scrape the groove with a toothpick;
6. Rinse inside the froth adjustment dial seat with running water (fig. 33);
7. Check that the intake tube and milk spout are not clogged with milk residues;

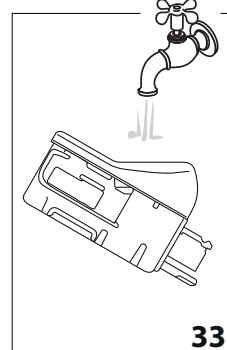

8. Replace the dial (in correspondence to the word "INSERT"), spout and milk intake tube;
9. Place the lid back on the milk container (D3).

## 14.7 Cleaning the hot water nozzle

Each time you prepare milk, clean the connection nozzle (A15) with a sponge to remove milk residues from the gaskets (fig. 20).



### 15. DESCALE



#### Important!

- Before use, read the instructions and the labelling on the descaler pack.
- You should use De'Longhi descaler only. Using unsuitable descaler and/or performing descaling incorrectly may result in faults not covered by the manufacturer's guarantee.

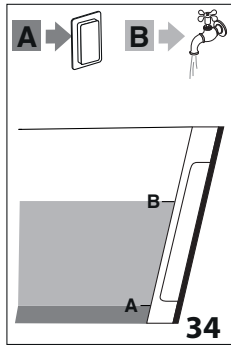

Descal the machine when "Descalce, ESC to cancel, OK to descale ( $\approx 45$  minutes)" appears on the display (B1). To descale immediately, press (B3) and follow the instructions from point 6. To descale the appliance later, press (B2): the display shows the symbol to remind you that the appliance needs descaling.

To access the descaling menu:

1. Turn the appliance on and wait until it is ready for use;
2. Press (B2) to enter the "Settings" menu;
3. Press the selection arrows (B4) or (B5) until "Maintenance" is displayed between the two dotted lines: press ;
4. Press the selection arrows or until "Descaling" is displayed between the two dotted lines: press ;
5. "Confirm? ( $\approx 45$  minutes)": confirm by pressing ;
6. (If the filter is installed) "Remove filter": extract the water tank (A18), remove the water softener filter (C4) and empty the water tank. Press or (B5);

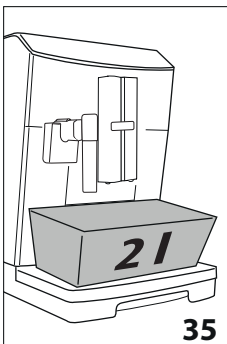

7. "Pour descaler and water into tank": Pour the descaler into the tank up to level A (corresponding to a 100ml pack) marked on the inner surface of the tank, then add water (one litre) up to level B (fig. 34) and put the water tank back. Press ;

8. "Empty drip tray": Remove, empty and replace the drip tray (A24) and grounds container (A20). Press ;
9. "Place 2L container empty under spouts": Place an empty container with a minimum capacity of 2 litres under the hot water spout (C6) and coffee spouts (A14) (fig. 35). Press ;



#### Important! Danger of burns

Hot water containing acid flows out of the coffee spouts and hot water spout. Take care to avoid contact with splashes of this solution.

10. "Descaling underway": The descale programme starts and the descaler liquid comes out of the hot water and coffee spouts.

A series of rinses and pauses is performed automatically to remove all the scale residues inside the coffee machine;

After about 25 minutes, descaling stops;

11. "Rinse tank and fill with water": the appliance is now ready to rinse with fresh water. Empty the container used to collect the descaler solution. Extract the water tank, empty, rinse under running water, fill with fresh water up to the MAX level and put back in the appliance: press ;
12. "Place 2L container empty under spouts": place the container used to collect the descaler solution empty under the coffee spouts and hot water spout (fig. 35) and press ;
13. "Rinsing Confirm?": press ;
14. "Rinsing underway": hot water is delivered first from the coffee spouts, then from the hot water spout;
15. When the water in the tank has run out, empty the container used to collect the rinsing water;
16. "Rinse tank and fill with water": extract the water tank and fill with fresh water up to the MAX level. Press ;
17. (If the filter is installed) "Insert filter": put the water softener filter (if previously removed) back in its housing in the water tank, and replace the tank in the appliance and press ;
18. "Place 2L container empty under spouts": place the container used to collect the descaler solution empty under the hot water spout. Press ;
19. "Rinsing Confirm?": press ;
20. "Rinsing underway": Hot water comes out of the hot water spout;
21. "Empty drip tray": At the end of the second rinse, remove, empty and replace the drip tray (A24) and grounds container (A20). Press ;
22. "Descalce complete": press ;



23. "Fill tank": empty the container used to collect the rinse water, remove the water tank and fill with fresh water up to the MAX level, then put back in the appliance.

Descaling is complete.

**i Please note!**

- If the descaling cycle is not completed correctly (e.g. no electricity) we recommend repeating the cycle;
- After descaling, it is normal for the grounds container (A20) to contain water;
- If the water tank has not been filled to the MAX level, at the end of descaling, the appliance requests a third rinse to guarantee that the descaler solution has been completely eliminated from the machine's internal circuits. Before starting rinsing, remember to empty the drip tray.
- The appliance may request descaling cycles at very short intervals. This is normal and due to the appliance's advanced control system.

## 16. SETTING WATER HARDNESS

The descaling request is displayed after a period of time established according to water hardness.

The machine is set by default for a hardness level of 4. The machine can also be programmed according to the hardness of the mains water in the various regions so that the machine needs to be descaled less often.

### 10.1 Measuring water hardness

1. Remove the "TOTAL HARDNESS TEST" indicator paper (C1) from its pack (attached to the English instructions);
2. Immerse the paper completely in a glass of water for one second;
3. Remove the paper from the water and shake lightly. After about a minute, 1, 2, 3, or 4 red squares form, depending on the hardness of the water. Each square corresponds to 1 level;

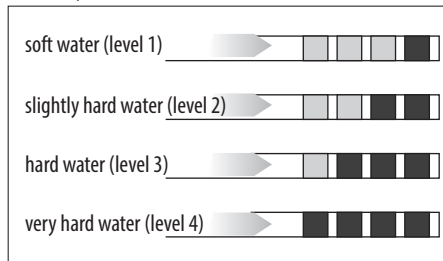

### 16.1 Setting water hardness

1. Press (B2) to enter the "Settings" menu;
2. Press the selection arrows (B4 and B5) until "General" is displayed between the two dotted lines": press (B3);

3. Press the selection arrows until "Water hardness" is displayed: press ;
4. The current selection appears on the display (B1) and the new selection flashes. Press the selection arrows until the required new selection is displayed. Press to confirm the selection.

The new level is saved and the appliance goes back to the "General" menu.

Then press twice to go back to the main screen.

## 17. WATER SOFTENER FILTER

Certain models are fitted with a water softener filter (C4). If this is not the case with your model, you are recommended to purchase one from De'Longhi Customer Services.

To use the filter correctly, follow the instructions below.

### 10.2 Installing the filter

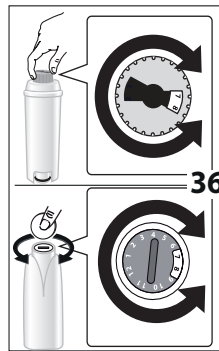

1. Remove the filter (C4) from the packaging. The date indicator disk varies according to the filter provided.
2. Turn the date indicator disk (fig. 36) until the next 2 months of use are displayed.

**i Please note**

The filter lasts about two months if the appliance is used normally. If the coffee machine

is left unused with the filter installed, it will last a maximum of 3 weeks.

3. To activate the filter, run tap water through the hole in the filter as shown in fig. 37 until water comes out of the openings at the side for more than a minute.;

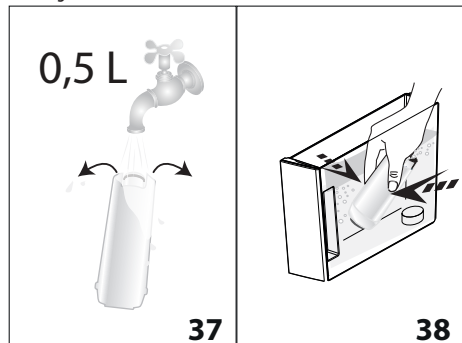

4. Extract the tank (A18) from the appliance and fill with water;

5. Insert the filter in the water tank and immerse it completely for about ten seconds, sloping it and pressing it lightly to enable the air bubbles to escape (fig. 38);
6. Insert the filter in the filter housing (A19) and press as far as it will go (fig. 39);
7. Close the tank with the lid (A17 - fig. 40), then replace the tank in the machine;

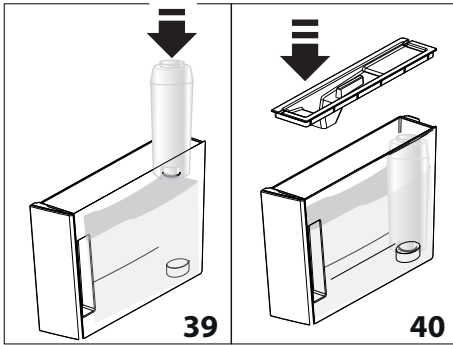

When you install the filter, you must notify the appliance of its presence.

8. Press (B2) to enter the “Settings” menu;
9. Press the selection arrows (B4 and B5) until “Maintenance” is displayed between the two dotted lines: press (B3);
10. Press the selection arrows until “Install filter” is displayed, then press ;
11. “Confirm?”: press (B5) or to confirm;
12. “Hot water, Confirm?”: position a container under the hot water spout (C6) (min. capacity: 500ml), then press or to start delivery;
13. The appliance begins hot water delivery and the message “Please wait” is displayed;
14. After the flow of hot water stops, the appliance automatically resets to “Ready for coffee” status.

The filter is now active and you can use the coffee machine.

## 2.1 Replacing the filter

Replace the filter (C4) when “Replace filter, ESC to cancel, OK to replace” appears on the display (B1). To replace immediately, press (B3) and follow the instructions from point 8. To replace the filter later, press (B2): the display shows the symbol to remind you that the filter needs replacing.

To replace, proceed as follows:

1. Extract the tank (A18) and exhausted filter;
2. Take the new filter out of its packet and proceed as illustrated in points 2, 3, 4, 5, 6 and 7 in the previous section;
3. Press to enter the “Settings” menu;
4. Press the selection arrows (B4 and B5) until “Maintenance” is displayed between the two dotted lines: press ;

5. Press the selection arrows until “Replace filter” is displayed, then press ;
6. “Confirm?”: press (B5) or to confirm;
7. “Hot water, Confirm?”: position a container under the hot water spout (C6) (min. capacity: 500ml), then press or (fig. 5) to start delivery;
8. The appliance begins hot water delivery and the message “Please wait” is displayed;
9. After the flow of hot water stops, the appliance automatically resets to “Ready for coffee” status.

The new filter is now active and you can use the coffee machine.

### Please note!

After two months (see date indicator) or when the appliance has not been used for 3 weeks, you should replace the filter even if the message has not yet been displayed.

## 2.2 Removing the filter

If you want to use the appliance without the filter (C4), you must remove it and notify the appliance of its removal. Proceed as follows:

1. Extract the tank (A18) and exhausted filter;
2. Press (B2) to enter the “Settings” menu;
3. Press the selection arrows (B4 and B5) until “Maintenance” is displayed between the two dotted lines: press (B3);
4. Press the selection arrows (B4) or (B5) until “Remove filter” is displayed: press ;
5. “Confirm?”: press or to confirm removal. The appliance goes back to the “Maintenance” menu;

Then press twice to exit the menu.

### Please note!

After two months (see date indicator) or when the appliance has not been used for 3 weeks, you should remove/replace the filter even if the message has not yet been displayed.

## 18. TECHNICAL DATA

Voltage:	220-240 V ~ 50/60 Hz max. 10A
Absorbed power:	1450W
Pressure:	1.9MPa (19 bars)
Max. water tank capacity:	2 l
Dimensions WxDxH:	240x465x350 mm
Cord length:	1750 mm
Weight:	11.8 kg
Max. beans container capacity:	250 g
Frequency:	2400 - 2483,5 MHz
Max transmit power	10 mW



This product is compliant with Regulation (EC) No. 1935/2004 on materials and articles intended to come into contact with food.

## 19. DISPOSING OF THE APPLIANCE









The appliance must not be disposed of with household waste, but taken to an authorised waste separation and recycling centre.



## 20. DISPLAYED MESSAGES

DISPLAYED MESSAGE	POSSIBLE CAUSE	REMEDY
Fill tank	Insufficient water in the tank (A18).	Fill the tank with water and/or insert it correctly, pushing it as far as it will go until it clicks into place (fig. 3B).
Insert tank	The tank (A18) is not correctly in place.	Insert the tank correctly and press as far as it will go (fig. 3B).
Empty grounds container	The grounds container (A20) is full.	Empty the grounds container and drip tray (A24), clean and replace. Important: when removing the drip tray, the grounds container must be emptied, even if it contains few grounds. If this is not done, when you make the next coffees, the grounds container may fill up more than expected and clog the machine.
Insert grounds container	After cleaning, the grounds container (A20) has not been replaced.	Remove the drip tray (A24) and insert the grounds container.
Add pre-ground coffee ESC to cancel	The “pre-ground coffee” function has been selected without placing any pre-ground coffee in the funnel (A6).	Place pre-ground coffee in the funnel or deselect the “pre-ground” function (fig. 11).
Add pre-ground coffee ▲ ESC                      OK ▼	A LONG coffee with pre-ground coffee has been requested	Put one level measure of pre-ground coffee into the pre-ground coffee funnel (A6) and press  (B3) to continue and complete preparation.
Fill beans container ESC to cancel	The coffee beans have run out.	Fill the beans container (A4) (fig. 8).
	The pre-ground coffee funnel (A6) is clogged.	Empty the funnel with the help of the brush (C5) as described in section “4.2 Cleaning the pre-ground coffee funnel”.
Ground too fine Adjust mill ESC to cancel	The grinding is too fine and the coffee is delivered too slowly or not at all.	Repeat coffee delivery and turn the grinding adjustment dial (A3) (fig. 7) one click clockwise towards “7” while the coffee mill is in operation. If after making at least 2 coffees delivery is still too slow, repeat the correction procedure, turning the grinding adjustment dial another click until delivery is correct (see section “5.1 Adjusting the coffee mill”). If the problem persists, make sure the water tank (A18) is fully inserted.
	If the water softener filter (C4) is present, an air bubble may have been released inside the circuit, obstructing delivery.	Insert the hot water spout (C6) in the appliance and deliver a little water until the flow becomes regular.

DISPLAYED MESSAGE	POSSIBLE CAUSE	REMEDY
Less coffee ESC to cancel	Too much coffee has been used.	Select a lighter taste by pressing  (B3) or reduce the quantity of pre-ground coffee.
Insert water spout	The hot water spout (C6) is not inserted or is inserted incorrectly.	Fully insert the hot water spout (fig. 4).
Insert milk container	The milk container (D) is not inserted correctly.	Insert the milk container as far as it will go (fig. 16).
Insert infuser assembly	The infuser has not been replaced after cleaning (A9).	Insert the infuser as described in section "14.1 Cleaning the infuser".
Water circuit empty Fill water circuit Hot water Confirm?	The water circuit is empty.	Press  (B3) to deliver water from the hot water spout (C6) until it flows out normally. If the problem persists, make sure the water tank (A18) is fully inserted.
Press OK to CLEAN	The milk container (D) has been inserted with the froth adjustment dial (D1) in the "CLEAN" position.	To proceed with the CLEAN function, press  (B3) or turn the froth adjustment dial to another position.
Set dial to CLEAN ESC to cancel	Milk has been delivered recently and the tubes inside the milk container must be cleaned (D).	Turn the froth adjustment dial (D1) to CLEAN (fig. 19).
Turn froth adjustment dial	The milk container (D) has been inserted with the froth adjustment dial (D1) in the "CLEAN" position.	Turn the froth adjustment dial to one of the milk froth positions.
Descale ESC to cancel OK to descale (≈45 minutes)	The machine must be descaled.	The descaling procedure described in section "15. Descale" needs to be performed.
Replace filter ESC to cancel OK to replace	The water softener filter (C4) is exhausted.	Replace the filter or remove it as described in section "17. Water softener filter".
General alarm	The inside of the appliance is very dirty.	Clean the inside of the appliance thoroughly, as described in section "14. Cleaning". If the message is still displayed after cleaning, contact customer services.
	The tubes inside the milk container (D) must be cleaned.	Turn the froth adjustment dial (D1) to CLEAN (fig. 19).
	The water softener filter (C4) is exhausted and must be replaced or removed.	Replace the filter or remove it as described in section "17. Water softener filter".
	The machine must be descaled.	The descaling procedure described in section "15. Descale" needs to be performed.
<b>ECO</b>	Energy saving is enabled.	To disable energy saving, proceed as described in section "8.2 General" - "• Energy saving."
	The appliance is connected to a device via Bluetooth.	



## 21. TROUBLESHOOTING

Below is a list of some of the possible malfunctions.

If the problem cannot be resolved as described, contact Customer Services.

PROBLEM	POSSIBLE CAUSE	REMEDY
The coffee is not hot.	The cups were not preheated.	Warm the cups by rinsing them with hot water (Please note: you can use the hot water function).
	The internal circuits of the appliance have cooled down because 2/3 minutes have elapsed since the last coffee was made.	Before making coffee, heat the infuser by performing a rinse cycle (see section "8.1 Rinsing").
	A low coffee temperature is set.	Set a higher coffee temperature in the menu (see section "8.2 General"- Set temperature,"").
The coffee is weak or not creamy enough.	The coffee is ground too coarsely.	Turn the grinding adjustment dial (A3) one click anticlockwise towards 1 while the coffee mill is in operation (fig. 7). Continue one click at a time until coffee delivery is satisfactory. The effect is only visible after delivering 2 coffees (see section "5.1 Adjusting the coffee mill").
	The coffee is unsuitable.	Use pre-ground coffee for espresso machines.
The coffee is delivered too slowly or a drop at a time.	The coffee is ground too finely.	Turn the grinding adjustment dial (A3) one click anticlockwise towards 7 while the coffee mill is in operation (fig. 7). Continue one click at a time until coffee delivery is satisfactory. The effect is only visible after delivering 2 coffees (see section "5.1 Adjusting the coffee mill").
The appliance will not make coffee	The appliance has detected impurities in its internal circuits. "Please wait" is displayed.	Wait for the appliance to be ready for use again and reselect the required beverage. Contact Customer Services if the problem persists.
Coffee does not come out of one or both of the spouts.	The coffee spouts (A14) are blocked.	Clean the spouts with a toothpick (fig. 24B).
The appliance does not come on	It is not plugged into the mains socket.	Plug into the mains socket (fig. 1).
	The main switch (A7) is not turned on.	Place the main switch in the I position (fig. 2).
	The power cord (C8) connector is not inserted correctly.	Insert the connector as far as it will go in the socket at the back of the appliance (fig. 1).
The infuser cannot be extracted	The appliance has not been turned off correctly	Turn the appliance off by pressing the  button (A12) (fig. 6) (see section "7. Turning the appliance off").

<b>PROBLEM</b>	<b>POSSIBLE CAUSE</b>	<b>REMEDY</b>
At the end of descaling, the appliance requests a third rinse	During the two rinse cycles, the water tank (A18) has not been filled to the MAX level.	Follow the instructions displayed by the appliance, but first empty the drip tray (A24) to avoid the water overflowing.
The milk does not come out of the milk spout (D5)	The lid (D2) of the milk container lid is dirty	Clean the milk container lid as described in section "4.3 Cleaning the milk container".
The milk contains large bubbles and squirts out of the milk spout (D5) or there is little froth	The milk is not cold enough or is not semi-skimmed or skimmed	Use skimmed or semi-skimmed milk at refrigerator temperature (about 5° C). If the result is not as you wished, try changing brand of milk.
	The froth adjustment dial (D1) is incorrectly adjusted.	Adjust following the instructions in section "8.1 Adjusting the amount of froth".
	The milk container lid (D2) or froth adjustment dial (D1) is dirty	Clean the milk container lid and froth adjustment dial as described in section "4.3 Cleaning the milk container".
	The hot water connection nozzle (A15) is dirty	Clean the connection nozzle as described in section "9.1 Cleaning the hot water nozzle".
The cup warmer is hot, even though it has been disabled	A number of beverages have been prepared in succession	
The machine emits noises or small puffs of steam while not in use	The machine is ready for use, or has recently been turned off, and condensate is dripping into the hot vaporiser	This is part of normal operation. To limit the phenomenon, empty the drip tray.