

Proudly distributed by
De'Longhi Australia Pty Limited
P.O. BOX 4540
CASULA MALL NSW 2170
Customer Service Ph: 1800 126 659
Fax: 1800 706932
www.delonghi.com.au
e-mail: delonghi@delonghi.com.au

De'Longhi New Zealand Limited
25 Carbine Road
Mt Wellington
Auckland, New Zealand
P.O. Box 58-056 Botany
MANUKAU 2163
Customer Service Ph: 0508 200 300
Fax: 0508 200 301
www.delonghi.com.nz
e-mail: delonghi@delonghi.com.nz

TCH8093ER

CERAMIC FAN HEATER
Instructions for use



DeLonghi

DESCRIPTION

Fig. 1

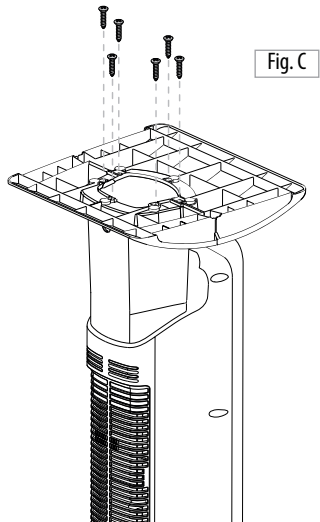
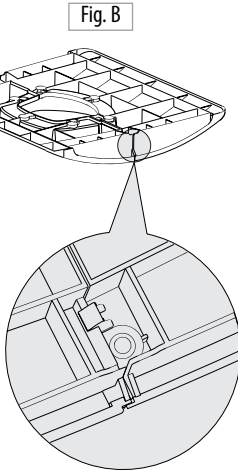
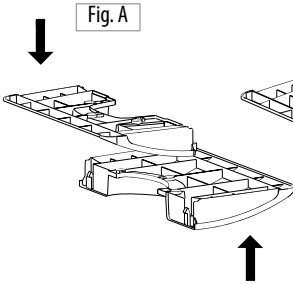
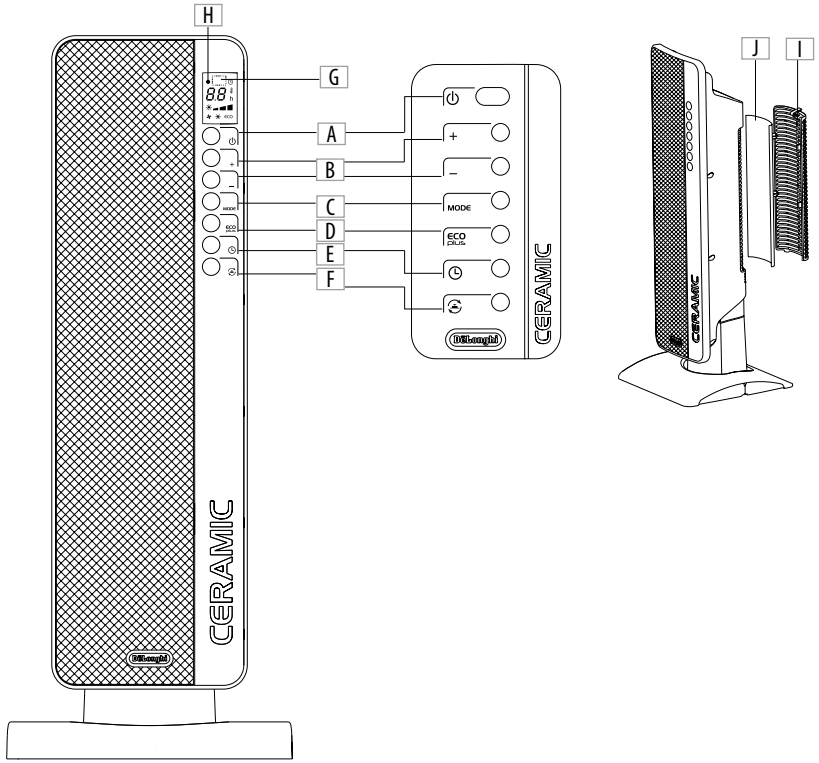

IMPORTANT WARNINGS

Safety warnings



Danger!

- Do not use the appliance near showers, bathtubs, sinks, swimming pools, etc.
- If the power cable is damaged, it must be replaced by the manufacturer, an authorised service centre or a qualified electrician in order to eliminate all risk.
- The appliance must not be placed immediately under a fixed power socket.



Important!

- Always use the appliance in an upright position.
- The appliance is not intended for use by persons (including children) with reduced physical, sensory or mental capabilities, or lack of experience and knowledge, unless they have been given supervision or instruction concerning use of the appliance by a person responsible for their safety. Children should be supervised to ensure that they do not play with the appliance.
- The use of extension leads is not recommended. However if they cannot be avoided, follow the instructions accompanying the extension lead and never exceed the power limit marked on the extension.



Danger of burns!!

- Do not use the appliance to dry laundry. Do not obstruct the air intake and outlet grilles (danger of overheating).
- The heater must be positioned at least 50 cm from furniture or other objects.
- Do not use the appliance near walls,

furniture, curtains, etc.

- Do not use the appliance in rooms with a floor area of less than 4m².



Please note:

- Before putting the appliance away, make sure it is completely off and unplugged from the mains socket. Wrap the cable around the base. Do not store in dusty atmospheres.
- Room temperature should be between 0 and 30° C.
- Do not rest anything on the appliance.
- To avoid the safety system resetting accidentally, this appliance must not be powered through an external on/off device such as a timer, or connected to a circuit which is turned off and on regularly by the energy supplier.



IMPORTANT: To avoid overheating, never under any circumstances cover the appliance during operation as this would lead to a dangerous rise in temperature.

INTRODUCTION

Thank you for choosing a De'Longhi product. Please take a few minutes to read these instructions. This will avoid all risks and damage to the appliance.

Symbols used in these instructions

Important warnings are identified by the symbols below.

It is important to respect the warnings.

Failure to respect the warnings could lead to electric shock, serious injury, burns, fire or damage to the appliance.



Danger!

Failure to observe the warning may result in life threatening injury by electric shock.



Important!

Failure to observe the warning could result in injury or damage to the appliance.



Danger of burns!!

Failure to observe the warning could result in burns or scalds.



Please note:

This symbol indicates recommendations and important information for the user.

Safety functions

- **Safety device:** the appliance is fitted with a safety device which switches it off in the event of accidental overheating (e.g. obstruction of air intake and outlet grilles, motor turning slowly or not at all).
To reset, unplug the appliance from the mains socket for a few minutes, remove the cause of overheating then plug in again.
- **Tip over safety device:** a tip over safety device turns the appliance off if it falls over or is positioned inappropriately in such a way as to jeopardise safety.
The appliance emits a beep and a dot flashes on the display. The appliance resumes operation a few seconds after being placed in an upright position again.

DESCRIPTION

(see fig. 1)

- A** ON/STAND-BY button
- B** +/- adjustment buttons
- C** MODE button (selects the operating mode)
- D** "ECO plus" button
- E** Timer button
- F** Swing button
- G** Remote control receiver
- H** Indicator light
- I** Air intake grille
- J** Filter

USE

Installation

- The appliance can be used on any horizontal surface.
Do not overload the electrical circuit. Avoid using the same socket for other appliances.

Electrical connection

- Before plugging the appliance into the mains socket, check that the mains power supply corresponds to the value indicated on the rating plate and that the mains power supply is adequate for the load.
- THIS APPLIANCE COMPLIES WITH DIRECTIVE 2004/108/EEC ON RADIO INTERFERENCE SUPPRESSION.

Mounting the base

- Fit the two parts of the base together, matching the guide pins on the front with the recesses on the back and snapping the two clips into place (fig. A and fig. B).
- Turn the appliance upside down and fix the base to the body with the 6 screws supplied (fig. C).

Operation and use

1. Plug into the mains socket.
2. The appliance emits a beep. The indicator light (H) comes on and remains lit while the appliance is powered.
3. The appliance switches to stand-by. A dot flashing on the display means the tip over device has been activated. See paragraph: "Safety functions".
4. Press the ON/STAND-BY (A) to turn the appliance on. It begins heating the room according to the current settings.
5. Press the MODE button (C) to select one of the following operating modes:

Fan ✨

Freeze prevention ✨

Heating 1 ✨ 

Heating 2 ✨ 

Heating 3 ✨ 

5.1 Fan ✨

In this mode, only the fan operates and the appliance does not heat the room.

5.2 Freeze prevention ✨

In this mode, the appliance keeps the room at a temperature of 7°C to avoid freezing.

5.3 Heating 1, 2 and Heating 3 ✨

In this mode, the desired temperature can be selected by pressing the adjustment buttons + and - (B). By pushing the + or - button once, the temperature (shown on the display) will increase or decrease by 1°C.

Heating 1 ✨ 

The appliance operates at low power, reducing noise levels and energy consumption to a minimum.

Heating 2 ✨ 

The appliance operates at medium power.

Heating 3 ✨ 

The appliance operates at high power to heat the room rapidly.

The setting temperature range available is from 16°C to 32°C.

6. "ECO plus" function

The "ECO plus" function is available in Heating 1, 2 and 3 modes only.

To activate the function, press the "ECO plus" button (D).

When this function is active the appliance automatically sets the most appropriate power level to guarantee optimum comfort while reducing energy consumption.



While the "ECO plus" function is active, the appliance may switch automatically to a lower heating power than the one displayed. This may happen a number of times in an hour.

- To distribute the air flow over a wider surface, press the swing button (F) . The appliance starts swinging to the right and left. To stop the appliance in the desired position, simply press the swing button (F) again.
- To turn the appliance off, press the ON/STAND-BY button (A). The display may visualize a countdown for about 6 seconds.



 **Please note:** Room temperature can be displayed in either °C or °F. To change the unit of measurement for the temperature, press the + button for a few seconds, then release.

Digital 24 h timer

This function can be activated from any operating mode.

Auto-start: with the appliance in STAND-BY, press the timer button (E) . The  symbol is displayed together with the time remaining before the appliance comes on. To adjust the timer, use the adjustment buttons + and - (B), then wait a few seconds for the setting to be memorised. The stand-by light (H) is displayed together with the  symbol, indicating that the timer has been set.

When the programmed time is reached, the appliance comes on with the settings used during the previous period of operation.

Auto-off: with the appliance on, press the timer button (E) . The  symbol is displayed together with the time remaining before the appliance goes off.

To set the timer, use the adjustment buttons + and - (B), then wait a few seconds for the setting to be memorised.

The current settings are displayed again, together with the  symbol indicating that the timer has been set.

When the programmed time is reached, the appliance goes off automatically. To go back to operation without the timer, press the timer button (E) twice.

The timer symbol  disappears from the display.

Using the remote control

The functions on the remote control are the same as those on the appliance control panel. For a description of the functions, see the "Operation and use" section on the previous page.

Inserting or replacing the batteries

The remote control is powered by a CR2032 lithium battery.

To operate the remote control, pull and remove the plastic strip under the battery cover.

To replace the batteries, remove the battery cover by sliding it as shown in the figure.

When replacing the batteries, make sure you respect the polarity (see figure 2).

Replace the cover as shown in the figure.

Old batteries are harmful to the environment and must be removed and disposed of in compliance with current legislation.

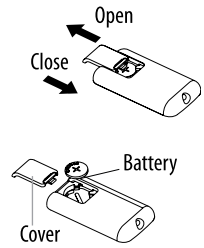

Fig. 2

MAINTENANCE

- Always unplug from the mains socket before cleaning.
- During the season when the appliance is in use, clean the air intake and outlet grilles regularly using a vacuum cleaner.
- To clean the filter, remove the rear grille by pulling it outwards (fig. 1).
Remove the dust filter which retains impurities in the air drawn in from the room, blow on it lightly then replace in the appliance.
- Never use abrasive powders or solvents to clean the appliance.

TROUBLESHOOTING

If the appliance displays "PF" and emits a beep, the temperature sensor is malfunctioning.

If the problem continues, contact customer services.

If the appliance goes off unexpectedly:

- Make sure it is plugged in correctly to the mains socket.
- Make sure the appliance is standing upright on a flat surface, otherwise the tip over device may be activated.
- Check the temperature and timer settings.
The appliance may have gone off because the set temperature has been reached or the time set on the timer has elapsed.

TECHNICAL CHARACTERISTICS

Power supply
Absorbed power

See rating plate

"